

Foreword

Thank you for choosing POWTRAN PI500 Series Frequency Inverter. This product made by POWTRAN is based on years of experience in professional production and sale, and designed for variety of industrial machinery, fan and water pump drive unit and IF heavy-duty grinding unit.

This manual provides user the relevant precautions on installation, operational parameter setting, abnormal diagnosis, routine maintenance and safe use. In order to ensure correct installation and operation of the frequency converter, please carefully read this manual before installing it.

For any problem when using this product, please contact your local dealer authorized by this company or directly contact this company, our professionals are happy to serve you.

The end-users should hold this manual, and keep it well for future maintenance & care, and other application occasions. For any problem within the warranty period, please fill out the warranty card and fax it to the our authorized dealer.

The contents of this manual are subject to change without prior notice. To obtain the latest information, please visit our website.

For more product information, please visit: [http:// www.powtran.com](http://www.powtran.com).

POWTRAN

July, 2015

Table of contents

Chapter 1. Inspection and safety precautions	1
1-1. Inspection after unpacking.....	1
1-2. Safety precautions	2
1-3. Precautions	3
1-4. Scope of applications.....	5
Chapter 2 Standard specifications	6
2-1. Technical specifications	6
2-2. Standard specifications	7
Chapter 3 Keyboard	10
3-1. Keyboard description.....	10
3-2. Keyboard Indicators	10
3-3. Description of operation panel keys	11
3-4. Keyboard display letters and numbers correspondence table ..	11
3-5. Examples of parameter settings	11
Chapter 4 Installation and commissioning	14
4-1. Use of the environment.....	14
4-2. Installation direction and space	14
4-3. Wiring Diagram.....	15
4-4. Main circuit terminal	17
4-5. Control circuit terminals.....	20
4-6. Wiring Precautions	23
4-7. Spare Circuit.....	24
4-8. Commissioning.....	25
Chapter 5 Function parameter	26
5-1. Menu grouping	26
5-2. Function parameter description	56
5-2-1. Basic monitoring parameters: d0.00-d0.41	56
5-2-2. Basic function group: F0.00-F0.27.....	59
5-2-3. Input terminal: F1.00-F1.46.....	65
5-2-4. Output terminal group: F2.00-F2.19.....	74
5-2-5. Start and stop control group: F3.00-F3.15	78
5-2-6. V/F control parameters: F4.00-F4.14	81
5-2-7. Vector control parameters: F5.00-F5.15.....	84
5-2-8. Keyboard and display: F6.00-F6.19	85

5-2-9. Auxiliary function: F7.00-F7.54	89
5-2-10. Fault and protection:F8.00-F8.35	96
5-2-11. Communication parameter: F9.00-F9.07	101
5-2-12. Torque control parameters FA.00-FA.07	102
5-2-13. Control optimization parameters: Fb.00-Fb.09	103
5-2-14. Extended parameter: FC.00-FC.02.....	104
5-2-15. Wobble, fixed-length and counting:E0.00-E0.11	104
5-2-16. Multi-stage command, simple PLC: E1.00 - E1.51.....	106
5-2-17. PID function: E2.00-E2.32.....	109
5-2-18. Virtual DI、 Virtual DO: E3.00 - E3.21	113
5-2-19. Motor parameters: b0.00-b0.35.....	115
5-2-20. Function code management: y0.00-y0.04	118
5-2-21. Fault query:y1.00-y1.30.....	120
Chapter 6 Troubleshooting	123
6-1. Fault alarm and countermeasures.....	123
6-2. EMC (Electromagnetic Compatibility).....	127
6-3. EMC directive.....	127
Chapter 7 Dimension	130
7-1. Dimension.....	130
Chapter 8 Maintenance and Repair	134
8-1. Inspection and Maintenance	134
8-2. Parts for regular replacement	134
8-3. Storage	135
8-4. Capacitor.....	135
8-5. Measuring and readings	136
Chapter 9 Options.....	137
9-1. Expansion cards	138
9-2. AC input reactor	138
9-3. AC output choke	140
9-4. DC choke	141
9-5. Input filter	142
9-6. Output filter	143
9-7. Brake unit and brake resistor	143
9-8. Main Circuit Breaker (MCCB), Contactor, Wire.....	144
Chapter 10 Warranty.....	147
Appendix I RS485 Communication protocol	148

Appendix II Description on proportion linkage function	156
Appendix III How to use universal encoder expansion card.....	158
Appendix IV CAN bus communication card use description	160
Appendix V: Instruction of Profitbus –DP communication card.-	161 -

Chapter 1. Inspection and safety precautions

POWTRAN frequency inverters have been tested and inspected before leaving factory. After purchasing, please check if its package is damaged due to careless transportation, and if the specifications and model of the product are consistent with your order requirements. For any problem, please contact your local authorized POWTRAN dealer or directly contact this company.

1-1. Inspection after unpacking

- ※ Check if that packing container contains this unit, one manual and one warranty card.
- ※ Check the nameplate on the side of the frequency inverter to ensure that the product you have received is right the one you ordered.

1-1-1. Instructions on nameplate

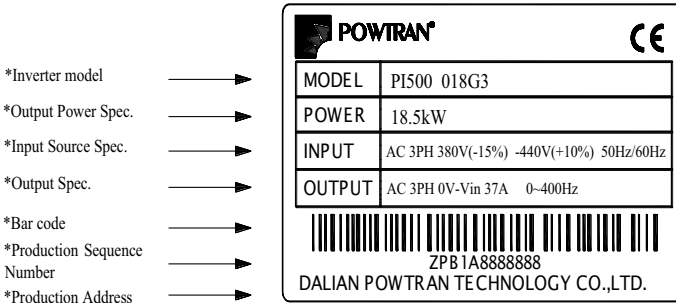

Diagram 1-1:Nameplate Description

1-1-2. Model designation

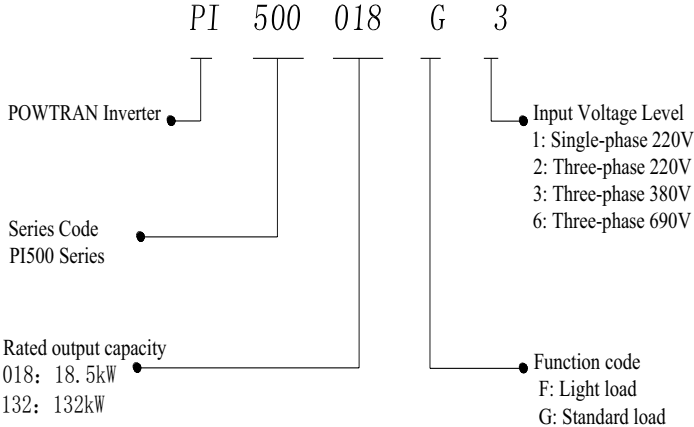









Diagram 1-2:Model Description





1-2.Safety precautions

Safety precautions in this manual are divided into the following two categories:

 **Danger:** the dangers caused by failure to perform required operation, may result in serious injury or even death;

 **Caution:**the dangers caused by failure to perform required operation, may result in moderate injury or minor injury, and equipment damage;

Process	Type	Explanation
Before installation	 Danger	<ul style="list-style-type: none"> •When unpacking, if control system with water, parts missed or component damaged are found, do not install! •If packing list does not match the real name, do not install! • Gently carry with care, otherwise there is the risk of damage to equipment! •Please do not use the damaged driver or the frequency inverter with missed pieces, otherwise there is the risk of injury! •Do not use your hand to touch the control system components, otherwise there is the risk of electrostatic damage!
	 Note	<ul style="list-style-type: none"> • Please install the unit on the metal or flame retardant objects; away from combustible material. Failure to do so may cause a fire! • Never twist the mounting bolts of the equipment components, especially the bolt with the red mark! • Do not let the lead wires or screws fall into the driver. Otherwise which may cause damage to the driver! • Keep the driver installed in the place where less vibration, avoid direct sunlight. • When two or more converters are installed in a cabinet, please pay attention to the installation location, ensure the good heat dissipation effect.
When installing	 Danger	<ul style="list-style-type: none"> • Must comply with this manual's guidance, any construction shall be performed by a professional electrician, otherwise there would be the unexpected risk ! • A circuit breaker must be set between the inverter and the power supply to separate them, otherwise it may cause a fire! • Verify if power is a zero-energy status before wiring, otherwise there is a risk of electric shock! • The inverter shall be grounded correctly according to standard specifications, otherwise there is a danger of electrical shock! • Ensure that the distribution line meets the regional safety standards of EMC requirements. The diameter of used wire shall refer to the recommendations of this manual. Otherwise it may cause an accident! • Never directly connect braking resistor to the DC bus P(+) and P(-) terminals. Otherwise it may cause a fire! • Encoder must use the shielded wire, and the shielding layer must ensure the single-ended grounded!
When wiring	 Danger	<ul style="list-style-type: none"> • Please confirm whether the input power voltage is same as the inverter rated voltage; wiring positions of power input terminals(R, S, T) and output terminals(U, V, W) are correct or not; and note that if there is a short circuit in the peripheral circuit connected to driver, if the connected lines are tight, otherwise it may cause damage to the driver! • Do not need to perform withstand voltage test for any part of the
Before energizing	 Note	<ul style="list-style-type: none"> • Do not need to perform withstand voltage test for any part of the

		inverter, this product has been tested before leaving factory. Otherwise it may cause an accident!
	 Danger	<ul style="list-style-type: none"> • The inverter's cover plate must be closed before power on. Otherwise it may cause an electric shock! • Wiring of all external accessories must comply with the guidance of this manual, please correctly wiring in accordance with the circuit connection methods described in this manual. Otherwise it may cause an accident!
After energizing	 Danger	<ul style="list-style-type: none"> • Do not open cover plate after energizing. Otherwise there is a risk of electric shock! • Do not touch the driver and peripheral circuits with wet hands. Otherwise there is a risk of electric shock! • Do not touch any input and output terminals of the inverter. Otherwise there is a risk of electric shock! • The inverter automatically perform the safety testing for the external strong electrical circuit in the early stages of energizing, therefore never touch the driver terminals(U, V, W) or motor terminals, otherwise there is a risk of electric shock! • If you need to identify the parameters, please pay attention to the danger of injury during motor rotation. Otherwise it may cause an accident! • Please do not change the inverter manufacturer parameters. Otherwise it may cause damage to this unit!
During operation	 Danger	<ul style="list-style-type: none"> • Do not touch the cooling fan and the discharge resistor to feel the temperature. Otherwise it may cause burns! • Non-professional personnel is not allowed to detect signal when operating. Doing so may cause personal injury or damage to this unit!
	 Note	<ul style="list-style-type: none"> • When the inverter is operating, you should avoid that objects fall into this unit. Otherwise cause damage to this unit! • Do not start/stop the driver by switching on/off contactor. Otherwise cause damage to this unit!
When maintaining	 Danger	<ul style="list-style-type: none"> • Do not perform repairs and maintenance for the live electrical equipment. Otherwise there is a risk of electric shock! • The repairs and maintenance task can be performed only when the inverter bus voltage is lower than 36V, otherwise, the residual charge from capacitor would cause personal injury! • Non-well-trained professional personnel is not allowed to perform repairs and maintenance of inverter. Doing this may cause personal injury or damage to this unit! • After replacing the inverter, parameter settings must be redone, all pluggable plugs can be operated only in the case of powering off!

1-3.Precautions

No.	Type	Explanation
1	Motor insulation inspection	Please perform motor insulation inspection for the first time use, re-use after leaving unused for a long time as well as regular check, in order to prevent damage to the inverter because of the motor's winding insulation failure. Wiring between motor and inverter shall be disconnected, it is recommended that the 500V voltage type megger should be adopted and insulation resistance shall be not less than 5MΩ.
2	Motor thermal protection	If the rated capacity of the selected motor does not match the inverter, especially when the inverter rated power is greater than

		the motor rated power, be sure to adjust the motor protection parameter values inside inverter or install thermal relay in the front of motor for motor protection.
3	Run over power frequency	The inverter output frequency rang is 0Hz to 3200Hz(Max. vector control only supports 300Hz). If the user is required to run at 50Hz or more, please consider the endurance of your mechanical devices.
4	Vibrations of mechanical device	Inverter output frequency may be encountered mechanical resonance point of the load device, you can set jump frequency parameter inside inverter to avoid the case.
5	Motor heat and noise	The inverter output voltage is PWM wave that contains a certain amount of harmonics, so the temperature rise, noise and vibration of motor show a slight higher than frequency power frequency operation.
6	Output side with piezoresistor or capacitor for proving power factor	The inverter output is PWM wave, if the piezoresistor for lightning protection or the capacitor for improving power factor is installed in the output side, which easily cause the inverter instantaneous overcurrent or even cause damage to the inverter. Please do not use.
7	Contact or switch used in the inverter input/output terminals	If contactor is installed between power supply and inverter, the contactor is not allowed to start/stop the inverter. Necessarily need to use the contactor to control the inverter start/stop, the interval should not be less than one hour. Frequent charging and discharging may reduce the service life of the inverter capacitor. If the contactor or switch is equipped between output terminals and motor, the inverter should be turned on/off without output status, otherwise which easily lead to damage to the inverter module.
8	Use other than the rated voltage	PI series inverter is not suitable for use beyond the allowable operating voltage described in this manual, which easily cause damage to the parts inside inverter. If necessary, please use the corresponding transformer to change voltage.
9	Never change 3-phase input to 2-phase input	Never change PI series 3-phase inverter to 2-phase one for application. Otherwise it will lead to malfunction or damage to the inverter.
10	Lightning surge protection	The series inverter is equipped with lightning overcurrent protection device, so it has the ability of self-protection to lightning induction. For the area where lightning is frequent, user should also install the extra protection in the front of the inverter.
11	High altitude and derating application	When the inverter is used in areas over 1000m altitude, it is required to reduce frequency because the thin air will decrease the cooling effect of inverter. Please consult our technician for details on the application.
12	Special use	If the user need to use methods other than the suggested wiring diagram provided in this manual, such as common DC bus, please consult our technician.
13	Precautions for scrap disposal of the inverter	When electrolytic capacitors on the main circuit and printed circuit board as well as plastic parts are burned, it may produce toxic gases. Please disposing as industrial waste.
14	Adaptive motor	1) Standard adaptive motor shall be four-pole asynchronous squirrel-cage induction motor or permanent magnet synchronous motor. Apart from the said motors, please select the inverter according to the motor rated current. 2) The cooling fan and the rotor shaft for non-inverter motor are coaxially connected, the fan cooling effect is reduced when the

		<p>rotational speed is reduced, therefore, when the motor works in overheating occasions, a strong exhaust fan should be retrofitted or replace non-inverter motor with the inverter motor.</p> <p>3) The inverter has built-in the adaptive motor standard parameters, according to the actual situation, please identify motor parameters or accordingly modify the default values to try to meet the actual value, otherwise it will operation affect and protection performance;</p> <p>4) When short-circuit of cable or motor internal will activate the inverter alarm, even bombing. Therefore, firstly perform insulation short-circuit test for the initial installation of the motor and cable, routine maintenance often also need to perform such test. Note that the parts to be tested and the inverter shall be disconnected completely when testing.</p>
15	Others	<p>1) We need to fix cover and lock before power on, so as to avoid the harm to personal safety that is caused by internal injuries of bad capacitors and other components.</p> <p>2) Do not touch internal circuit board and any parts after powering off and within five minutes after keyboard indicator lamp goes out, you must use the instrument to confirm that internal capacitor has been discharged fully, otherwise there is a danger of electric shock.</p> <p>3) Body static electricity will seriously damage the internal MOS field-effect transistors, etc., if there are not anti-static measures, do not touch the printed circuit board and IGBT internal device with hand, otherwise it may cause a malfunction.</p> <p>4) The ground terminal of the inverter (E or \perp) shall be earthed firmly according to the provisions of the National Electrical Safety and other relevant standards. Do not shut down (power off) by pulling switch, and only cut off the power until the motor stopping operation.</p> <p>5) It is required to add the optional input filter attachment so as to meet CE standards.</p>

1-4. Scope of applications

- ※ This inverter is suitable for three-phase AC asynchronous motor and permanent magnet synchronous motor.
- ※ This inverter can only be used in those occasions recognized by this company, an unapproved use may result in fire, electric shock, explosion and other accidents.
- ※ If the inverter is used in such equipment (e.g: equipment for lifting persons, aviation systems, safety equipment, etc.) and its malfunction may result in personal injury or even death. In this case, please consult the manufacturer for your application.

Only the well-trained personnel can be allowed to operate this unit, please carefully read the instructions on safety, installation, operation and maintenance before use.

The safe operation of this unit depends on proper transport, installation, operation and maintenance!

Chapter 2 Standard specifications

2-1. Technical specifications

Model	Rated output power(kW)	Rated input current(A)	Rated output current(A)	Adaptive motor(kW)
PI500-7R5G3/PI500-011F3	7.5/11	20.5/26	17/25	7.5/11
PI500-011G3/PI500-015F3	11/15	26/35	25/32	11/15
PI500-015G3/PI500-018F3	15/18.5	35/38.5	32/37	15/18.5
PI500-018G3/PI500-022F3	18.5/22	38.5/46.5	37/45	18.5/22
PI500-022G3/PI500-030F3	22/30	46.5/62	45/60	22/30
PI500-030G3/PI500-037F3	30/37	62/76	60/75	30/37
PI500-037G3/PI500-045F3	37/45	76/91	75/90	37/45
PI500-045G3/PI500-055F3	45/55	91/112	90/110	45/55
PI500-055G3/PI500-075F3	55/75	112/157	110/150	55/75
PI500-075G3	75	157	150	75
PI500-093F3	93	180	176	93
PI500-093G3/PI500-110F3	93/110	180/214	176/210	93/110
PI500-110G3/PI500-132F3	110/132	214/256	210/253	110/132
PI500-132G3/PI500-160F3	132/160	256/307	253/304	132/160
PI500-160G3/PI500-187F3	160/187	307/345	304/340	160/187
PI500-187G3/PI500-200F3	187/200	345/385	340/380	187/200
PI500-200G3/PI500-220F3	200/220	385/430	380/426	200/220
PI500-220G3	220	430	426	220
PI500-250F3	250	468	465	250
PI500-250G3/PI500-280F3	250/280	468/525	465/520	250/280
PI500-280G3/PI500-315F3	280/315	525/590	520/585	280/315
PI500-315G3/PI500-355F3	315/355	590/665	585/650	315/355
PI500-355G3/PI500-400F3	355/400	665/785	650/725	355/400
PI500-400G3	400	785	725	400
PI500-450F3	450	883	820	450
PI500-450G3/PI500-500F3	450/500	883/920	820/860	450/500
PI500-500G3/PI500-560F3	500/560	920/1010	860/950	500/560
PI500-560G3/PI500-630F3	560/630	1010/1160	950/1100	560/630
PI500-630G3/PI500-700F3	630/700	1160/1310	1100/1250	630/700

Chapter 2

2-2.Standard specifications

Items		Specifications		
Power Input	Rated voltage	AC 3PH 380V(-15%)~440V(+10%)		
	Input frequency	50Hz/60Hz		
	Allowing fluctuations	Voltage continued volatility: $\pm 10\%$	Less than 3% of voltage unbalance rate 3%;	
Input frequency fluctuation: $\pm 5\%$;		Distortion satisfy IEC61800-2 standard		
Control system	Control system	High performance vector control inverter based on DSP		
	Control method	V/F control, vector control W/O PG, vector control W/ PG		
	Automatic torque boost function	Realize low frequency (1Hz) and large output torque control under the V/F control mode.		
	Acceleration/deceleration control	Straight or S-curve mode. Four times available and time range is 0.0 to 6500.0s.		
	V/F curve mode	Linear, square root/m-th power, custom V/F curve		
	Over load capability	G type:rated current 150% - 1 minute, rated current 180% - 2 seconds F type:rated current 120% - 1 minute, rated current 150% - 2 seconds		
	Maximum frequency	1、 Vector control:0 to 300Hz; 2、 V/F control:0 to 3200Hz		
	Carrier Frequency	0.5 to 16kHz; automatically adjust carrier frequency according to the load characteristics.		
	Input frequency resolution	Digital setting: 0.01Hz Analog setting: maximum frequency $\times 0.1\%$		
	Start torque	G type: 0.5Hz/150% (vector control W/O PG) F type: 0.5Hz/100% (vector control W/O PG)		
	Speed range	1:100 (vector control W/O PG) 1:1000 (vector control W/ PG)		
	Steady-speed precision	Vector control W/O PG: $\leq \pm 0.5\%$ (rated synchronous speed) Vector control W/ PG: $\leq \pm 0.02\%$ (rated synchronous speed)		
	Torque response	$\leq 40\text{ms}$ (vector control W/O PG)		
	Torque boost	Automatic torque boost; manual torque boost(0.1% to 30.0%)		
	DC braking	DC braking frequency: 0.0Hz to max. frequency, braking time: 0.0 to 100.0 seconds, braking current value: 0.0% to 100.0%		
	Jogging control	Jog Frequency Range: 0.00Hz to max. frequency; Jog Ac/deceleration time: 0.0s to 6500.0s		
	Multi-speed operation	Achieve up to 16-speed operation through the control terminal		
	Built-in PID	Easy to realize closed-loop control system for the process control.		
	Personalization function	Automatic voltage regulation(AVR)	Automatically maintain a constant output voltage when the voltage of electricity grid changes	
		Torque limit and control	"Excavator" feature - torque is automatically limited during the operation to prevent frequent overcurrent trip; the closed-loop vector mode is used to control torque.	
Self-inspection of peripherals after power-on		After powering on, peripheral equipment will perform safety testing, such as ground, short circuit, etc.		
Common DC bus function		Multiple inverter can use a common DC bus.		
Quick current limiting		The current limiting algorithm is used to reduce the inverter over current probability, and improve whole unit anti-interference capability.		
	Timing control	Timing control function: time setting range(0m to 6500m)		

Running	Input signal	Running method	Keyboard/terminal/communication
		Frequency setting	10 frequency settings available, including adjustable DC(0 to 10V), adjustable DC(0 to 20mA), panel potentiometer, etc.
		Start signal	Rotate forward/reverse
		Multi-speed	At most 16-speed can be set(run by using the multi-function terminals or program)
		Emergency stop	Interrupt controller output
		Wobulate run	Process control run
		Fault reset	When the protection function is active, you can automatically or manually reset the fault condition.
		PID feedback signal	Including DC(0 to 10V), DC(0 to 20mA)
	Output Signal	Running status	Motor status display, stop, ac/deceleration, constant speed, program running status.
		Fault output	Contact capacity :normally closed contact 3A/AC 250V, normally open contact5A/AC 250V, 1A/DC 30V.
		Analog output	Two-way analog output, 16 signals can be selected such as frequency, current, voltage and other, output signal range (0 to 10V / 0 to 20mA).
		Output signal	At most 4-way output, there are 40 signals each way
	Run function	Limit frequency, jump frequency, frequency compensation, auto-tuning, PID control	
	DC current braking	Built-in PID regulates braking current to ensure sufficient braking torque under no overcurrent condition.	
Running command channel	Three channels: operation panel, control terminals and serial communication port. They can be switched through a variety of ways.		
Frequency source	Total 10 frequency sources: digital, analog voltage, analog current, multi-speed and serial port. They can be switched through a variety of ways.		
Input terminals	8 digital input terminals, compatible with active PNP or NPN input mode, one of them can be for high-speed pulse input(0 to 100 kHz square wave); 3 analog input terminals for voltage or current input.		
Output terminals	2 digital output terminals, one of them can be for high-speed pulse output(0 to 100kHz square wave); one relay output terminal; 2 analog output terminals respectively for optional range (0 to 20mA or 0 to 10V), they can be used to set frequency, output frequency, speed and other physical parameters.		
Protection function	Inverter protection	Overvoltage protection, undervoltage protection, overcurrent protection, overload protection, overheat protection, overcurrent stall protection, overvoltage stall protection, losing-phase protection (optional), communication error, PID feedback signal abnormalities, PG failure and short circuit to ground protection.	
	IGBT temperature display	Displays current temperature IGBT	
	Inverter fan control	Can be set	
	Instantaneous power-down restart	Less than 15 milliseconds: continuous operation. More than 15 milliseconds: automatic detection of motor speed, instantaneous power-down restart.	
	Speed start tracking method	The inverter automatically tracks motor speed after it starts	
	Parameter protection function	Protect inverter parameters by setting administrator Password and decoding	

Display	LED/OLE ED display keyboard	Running information	Monitoring objects including: running frequency, set frequency, bus voltage, output voltage, output current, output power, output torque, input terminal status, output terminal status, analog AI1 value, analog AI2 value, motor Actual running speed, PID set value percentage, PID feedback value percentage.
		Error message	At most save three error message, and the time, type, voltage, current, frequency and work status can be queried when the failure is occurred.
	LED display		Display parameters
	OLED display		Optional, prompts operation content in Chinese/English text.
	Copy parameter		Can upload and download function code information of frequency converter, rapid replication parameters.
	Key lock and function selection		Lock part or all of keys, define the function scope of some keys to prevent misuse.
	Communication	RS485	The optional completely isolated RS485 communication module can communicate with the host computer.
Environment Product standard	Environment temperature		-10℃to 40℃ (temperature at 40 ℃to 50℃, please derating for use)
	Storage temperature		-20 ℃ to 65 ℃
	Environment humidity		Less than 90% R.H, no condensation.
	Vibration		Below 5.9m/s ² (= 0.6g)
	Application sites		Indoor where no sunlight or corrosive, explosive gas and water vapor, dust, flammable gas,oil mist, water vapor, drip or salt, etc.
	Altitude		Below 1000m
	Pollution degree		2
Protection level		IP20	
Product standard	Product adopts safety standards.		IEC61800-5-1:2007
	Product adopts EMC standards.		IEC61800-3:2005
Cooling method		Forced air cooling	

Chapter 3 Keyboard

3-1.Keyboard description











Diagram 3-1:Operation panel display

3-2.Keyboard Indicators

Indicator flag		Name		
Status lamp Status lamp	RUN	Running indicator light * ON: the inverter is working * OFF: the inverter stops		
	LOCAL/REMOTE	Command indicator light That is the indicator for keyboard operation, terminal operation and remote operation (communication control) * ON: terminal control working status * OFF: keyboard control working status * Flashing: remote control working status		
	FWD/REV	Forward/reverse running light * ON: in forward status * OFF: in reversal status		
	TUNE/TC	Motor self-learning/Torque control/Fault indicator * ON: in torque control mode * Slow flashing: in the motor tuning status * Quick flashing: in the fault status		
Units combination indicator	HzAV		Hz	frequency unit
			A	current unit
			V	voltage unit
			RPM	speed unit
			%	percentage

3-3. Description of operation panel keys

Sign	Name	Function
	Parameter Setting/Esc Key	* Enter into the modified status of main menu * Esc from functional parameter modification * Esc submenu or functional menu to status menu
	Shift Key	*Choose displayed parameter circularly under running or stop interface; choose parameter's modified position when modify parameter
	Increasing Key	Parameter or function number increasing, set by parameter F6.18.
	Decreasing key	Parameter or function number decreasing, set by parameter F6.19.
	Running key	For starting running in the mode of keyboard control status
	Stomp/Reset Key	*For stopping running in the running status; for resetting the operation in fault alarm status. The function of the key is subject to F6.00
	Running key	For starting running in the mode of keyboard control status
	Quick multifunction key	This key function is determined by the function code F6.21.
	Keyboard encoder	* In query status, function parameter increasing or decreasing * In modified status, the function parameter or modified position increasing or decreasing. * In monitoring status, frequency setting increasing or decreasing

3-4..Keyboard display letters and numbers correspondence table

Keyboard display character	Character meaning	Keyboard display character	Character meaning	Keyboard display character	Character meaning	Keyboard display character	Character meaning	Keyboard display character	Character meaning
0	0	1	1	2	2	3	3	4	4
6	6	7	7	8	8	9	9	A	A
b	b	C	C	d	d	E	E	F	F
G	G	H	H	I	I	L	L	n	n
N	N	o	o	P	P	U	U	r	r
r	T	S	S	t	t	.	.	-	-

3-5.Examples of parameter settings

3-5-1. Instructions on viewing and modifying function code

PI500 inverter's operation pane is three levels menu for parameter setting etc. Three levels: function parameter group (Level 1)→function code(level 2)→function code setting(level 3). The operation is as following:

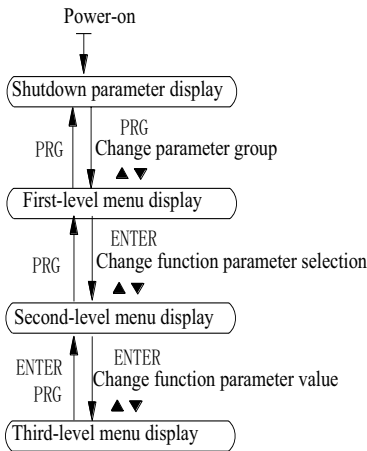
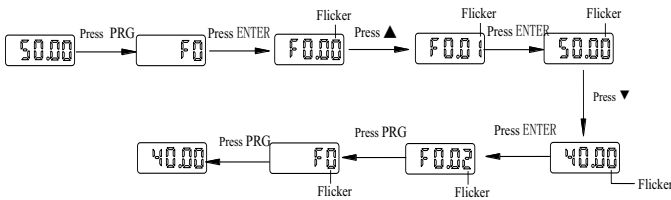

Diagram 3-2: Operation processes

Description: Back to the level 2 menu from level 3 menu by PRG key or ENTER key in the level 3 operation status. The differences between the two keys : ENTER will be back to the level 2 menu and save parameter setting before back, and transfer to the next function code automatically; PRG will be back to the level 2 menu directly, not save parameter setting, then back to current function code.

Example 1 Frequency setting to modify parameters
Set F0.01 from 50.00Hz to 40.00Hz



Example 2 :Restore factory settings

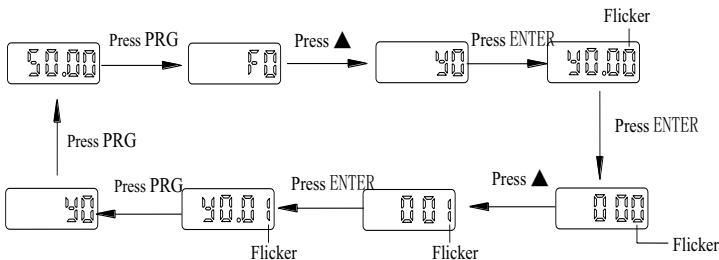

Without twinkling parameter position, the function code can not be modified in the level 3 menu. The reason maybe as following:

- 1) The function code can not be modified itself, eg: actual detecting parameters, running

record parameters.

2) The function code can not be modified in the running status. It must be modified in the stop status.

3-5-2. The way to read parameters in various status

In stop or run status, operate shift key  to display a variety of status parameters respectively. Parameter display selection depends on function code F6.01 (run parameter 1), F6.02 (run parameter 2) and F6.03 (stop parameter 3).

In stop status, there are total 16 stop status parameters that can be set to display/not display: set frequency, bus voltage, DI input status, DO output status, analog input AI1 voltage, analog input AI2 voltage, panel potentiometer input voltage, Actual count value, Actual length value, PLC running step number, Actual speed display, PID settings, high-speed pulse input frequency and reserve, switch and display the selected parameter by pressing key orderly.

In running status, there are 5 running-status parameters: running frequency, setting frequency, bus voltage, output voltage, output current default display, and other display parameters: output power, output torque, DI input status, DO output status, analog input AI1 voltage, analog input AI2 voltage, panel potentiometer input voltage, Actual count value, Actual length value, linear speed, PID settings and PID feedback, etc, their display depends on function code F6.01 and F6.02 switch and display the selected parameter by pressing key orderly.

Inverter powers off and then powers on again, the displayed parameters are the selected parameters before power-off.

3-5-3. Password settings

The inverter has password protection. When y0.01 become not zero, it is the password and will be work after exit from function code modified status. Press PRG key again, will display"----". One must input the correct password to go to regular menu, otherwise, inaccessible.

To cancel the password protection function, firstly enter correct password to access and then set y0.01 to 0.

3-5-4. Motor parameter auto turning

Choose vector control, one must input the motor's parameters in the nameplate accurately before running the inverter. PI500 series frequency inverter will match the motor's standard parameters according to its nameplate. The vector control is highly depend on motor's parameters. The parameters of the controlled motor must be inputted accurately for the good control performance.

Motor parameter auto tuning steps are as follows:

Firstly select command source (F0.11=0) as the comment channel for operation panel, then input the following parameters according to the actual motor parameters (selection is based on the current motor):

Motor Selection	Parameters
Motor	b0.00: motor type selection b0.01: motor rated power b0.02: motor rated voltage b0.03: motor rated current b0.04: motor rated frequency b0.05: motor rated speed

For asynchronous motors

If the motor can NOT completely disengage its load, please select 1 (asynchronous motor parameter static auto turning) for b0.27, and then press the RUN key on the keyboard panel.

If the motor can completely disengage its load, please select 2 (asynchronous motor parameter comprehensive auto turning) for b0.27, and then press the RUN key on the keyboard panel, the inverter will automatically calculate the motor's following parameters:

Motor Selection	Parameters
Motor	b0.06: asynchronous motor stator resistance b0.07: asynchronous motor rotor resistance b0.08: asynchronous motor leakage inductance b0.09: asynchronous motor mutual inductance b0.10: asynchronous motor no-load current

Complete motor parameter auto turning

Chapter 4 Installation and commissioning

4-1. Use of the environment

- (1) Environmental temperature -10°C to 50°C Above 40°C, the capacity will decrease 3% by each 1°C. So it is not advisable to use inverter above 50°C
- (2) Prevent electromagnetic interference, and away from interference sources.
- (3) Prevent the ingress of droplets, vapor, dust, dirt, lint and metal fine powder.
- (4) Prevent the ingress of oil, salt and corrosive gases.
- (5) Avoid vibration.
- (6) Avoid high temperature and humidity or exposure to rain, humidity shall be less than 90% RH (non-condensing).
- (7) Altitude below 1000 meters
- (8) Never use in the dangerous environment of flammable, combustible, explosive gas, liquid or solid.

4-2. Installation direction and space

PI500 series inverter according to different power rating, the requirements of around installation reserve space is different, specifically as shown below:

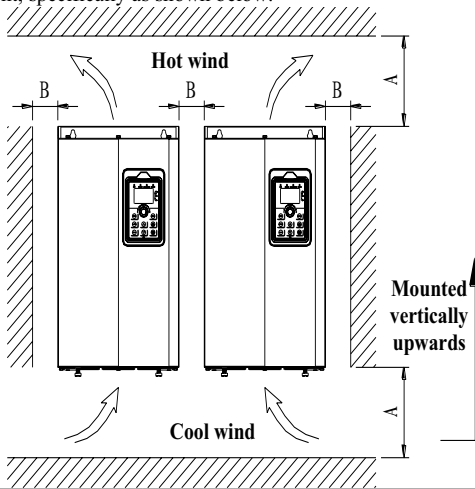

Power rating	Dimension requirement
7.5KW~22KW	A≥200mm; B≥10mm
30KW~75KW	A≥200mm; B≥50mm
90KW~400KW	A≥300mm; B≥50mm

Diagram 4-1: PI500 Series Each power level installation space requirement

PI500 Series frequency inverter heat radiator circulated from bottom to top, when more than one inverter work together, usually mounted side by side. In the case of the need to install them by upper and lower rows, due to the heat of the lower inverters rising to the upper equipment, fault may be caused, heat insulation deflector and other objects to be installed.

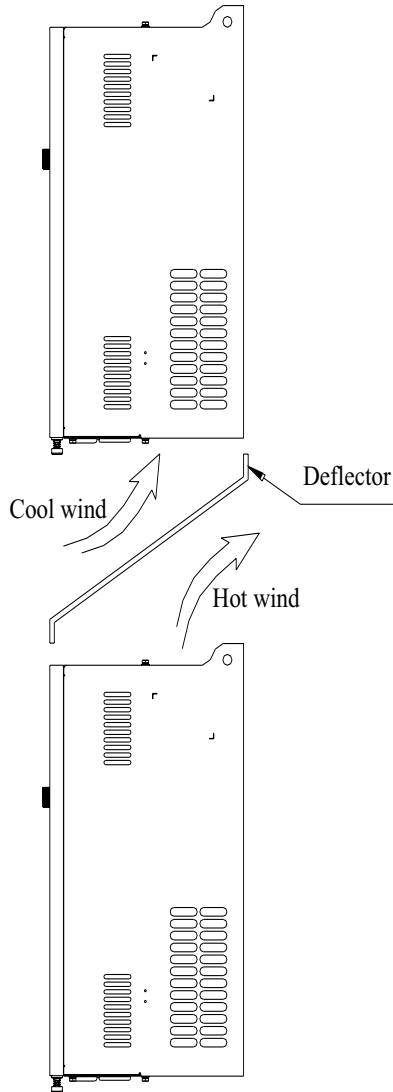

Diagram 4-2: Heat insulation deflector up and down installation diagram

4-3. Wiring Diagram

Frequency inverter wiring is divided by main circuit and control circuit. Users must properly connect frequency inverter in accordance with the wiring connection diagram showing below.

4-3-1. Wiring diagram

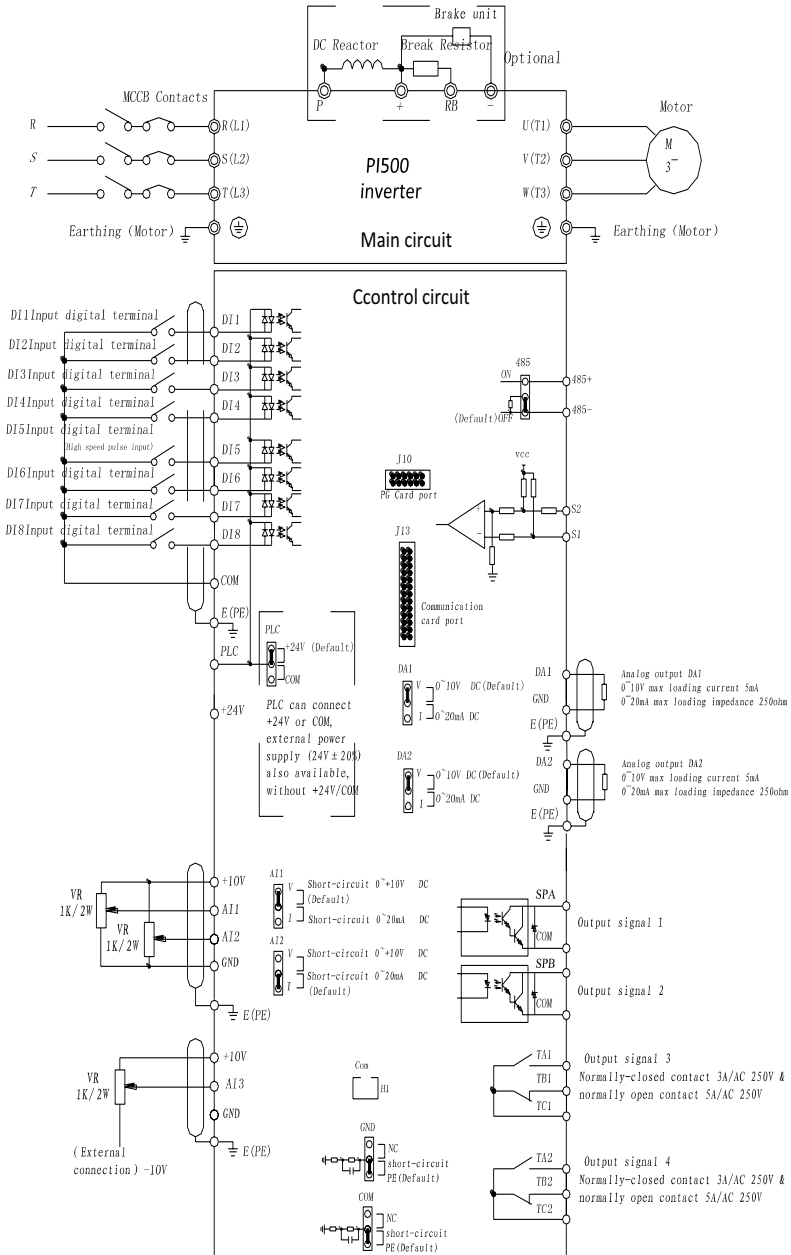

Diagram 4-3: Wiring diagram

4-4. Main circuit terminal

4-4-1. Main circuit terminal arrangement

1. 7.5kW~15kW G3 main circuit terminal

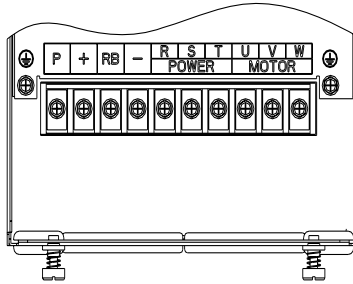

Diagram 4-4: 7.5kW~15kW G3 main circuit terminal

2. 18.5kW~22kW G3 main circuit terminal

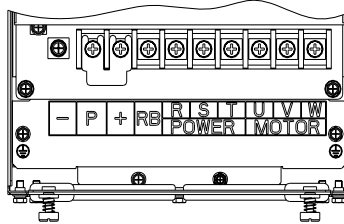

Diagram 4-5: 18.5kW~22kW G3 main circuit terminal

3. 30kW~37kW G3 main circuit terminal

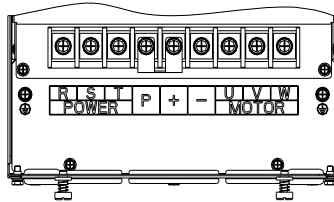

Diagram 4-6: 30kW~37kW G3 main circuit terminal

4. 45kW~75kW G3 main circuit terminal

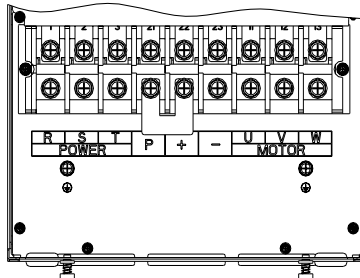

Diagram 4-7: 45kW~75kW G3 main circuit terminal

5. 93kW~110kW G3 main circuit terminal

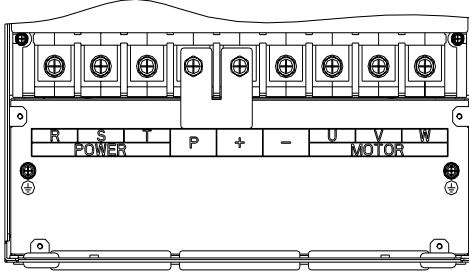

Diagram 4-8: 93kW~110kW G3

6. 132kW main circuit terminal

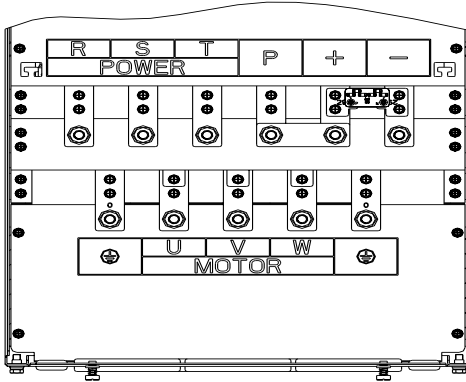

Diagram 4-9: 132kW G3 main circuit terminal

7. 160kW~220kW G3 main circuit terminal

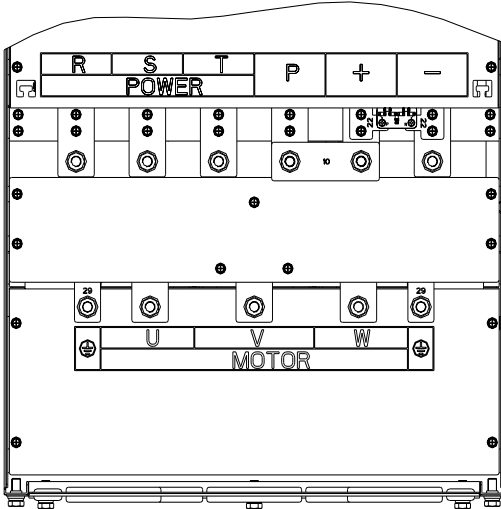

Diagram 4-10: 160kW~220kW G3 main circuit terminal

8. 250kW~400kW G3 main circuit terminal

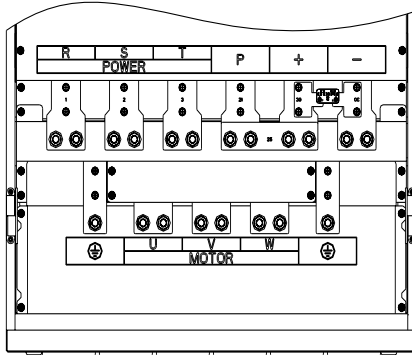

Diagram 4-11: 250kW~400kW G3 main circuit terminal

9. 450kW~630kW G3 main circuit terminal

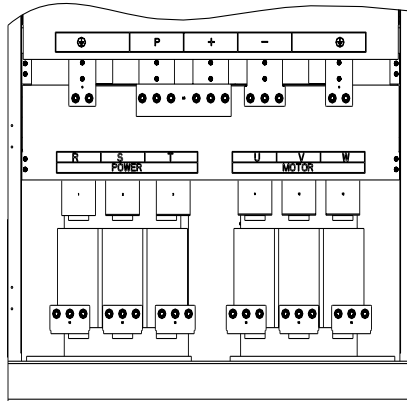

Diagram 4-12: 450kW~630kW G3 main circuit terminal

Note: P/+ standard is circuit standard configuration is for the shorted state; if external DC reactor is connected, firstly disconnect and then reconnect.

4-4-2. Function description of main circuit terminal

Terminal	Name	Explain
R	Inverter input terminals	Connect to three-phase power supply, single-phase connects to R, T
S		
T		
⊕	Ground terminals	Connect to ground
P, RB	Braking resistor terminals	Connect to braking resistor
U	Output terminals	Connect to three-phase motor
V		
W		
+, -	DC bus output terminals	Connect to braking unit
P, +	DC reactor terminals	Connect to DC reactor(remove the shorting block)

4-5. Control circuit terminals

4-5-1. Control circuit terminals arrangement

1. Control panel control circuit terminals

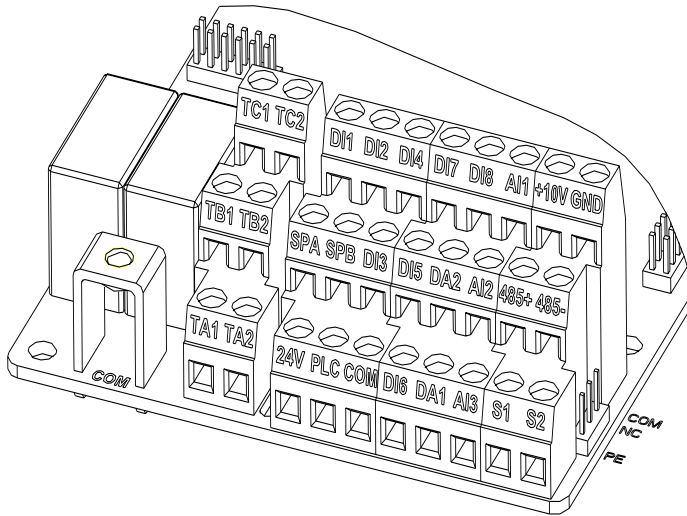

Diagram 4-13: Control panel control circuit terminals

4-5-2. Description of control circuit terminals

Category	Symbol	Name	Function
Power supply	+10V-GND	+10V power supply	Output +10V power supply, maximum output current: 10mA Generally it is used as power supply of external potentiometer, potentiometer resistance range: 1kΩ to 5kΩ
	+24V-COM	+24V power supply	Output +24V power supply, generally it is used as power supply of digital input and output terminals and external sensor. Maximum output current: 200mA
	PLC	External power input terminal	When external signal is used to drive, please unplug PLC jumpers , PLC must be connected to external power supply, and to +24V (default).
Analog input	AI1-GND	Analog input terminal 1	1. Input range:(DC 0V to 10V/0 to 20mA), depends on the selected AI1 jumper on control panel. 2. Input impedance: 20kΩ with voltage input, 510Ω with current input.
	AI2-GND	Analog input terminal 2	1. Input range:(DC 0V to 10V/0to 20mA), depends on the selected AI2 jumper on control panel. 2. Input impedance: 20kΩ with voltage input, 510Ω with current input.
	AI3-GND	Analog input terminal 3	1, Input range:DC -10V~+10V 2, Input voltage 20kΩ
Digital input	DI1	Multi-function digital input 1	1. Opto-coupler isolation, compatible with bipolar input, Jump line PLC selection decisions;
	DI2	Multi-function	2. Input impedance: 4.7kΩ

Category	Symbol	Name	Function
		digital input 2	3.Voltage range with level input: 19.2V to 28.8V;input impedance 3.3kΩ
	D13	Multi-function digital input 3	
	D14	Multi-function digital input 4	
	D15	Multi-function digital input 5	
	D16	Multi-function digital input 6	
	D17	Multi-function digital input 7	
	D18	Multi-function digital input 8	
		D15	High-speed pulse input terminals
Analog output	DA1-GND	Analog output 1	The selected DA1 jumper on control panel determines voltage or current output. Output voltage range: 0V to 10V , output current range: 0mA to 20mA
	DA2-GND	Analog output 2	The selected DA2 jumper on control panel determines voltage or current output. Output voltage range: 0V to 10V , output current range: 0mA to 20mA
Digital output	SPA-COM	Digital output 1	Opto-coupler isolation, bipolar open collector output Output voltage range: 0V to 24V , output current range: 0mA to 50mA
	SPB-COM	Digital output 2	
	SPB-COM	High-speed pulse output	Subject to function code(F2.00)"SPB terminal output mode selection" As a high-speed pulse output, the highest frequency up to 100kHz;
Relay output	TA1-TC1	Normally open terminals	Contactor drive capacity: normally closed contact 3A/AC 250V , normally open contact 5 A/AC 250V, COSφ = 0.4.
	TB1-TC1	Normally closed terminals	
Motor temperature inspection input	S1-S2-GND	PT100 inspect wire input	PT100 temperature sensor
Built-in RS485	485+	485 differential signal + terminal	485 communication interface, 485 differential signal terminal, use twisted-pair or shielded wire connect to the standard 485 communication interface 485 jump line in the control panel to decide whether to connect the terminal resistance
	485-	485 differential signal - terminal	
Auxiliary interface	J13	communication interface	CAN card, 26-pin terminal
	J10	PG card interface	12-pin terminal
	GND	GND ground interface	GND jump line decide whether to connect PE, improve the inverter anti-interference
	COM	COM ground interface	COM jump line decide whether to connect PE, improve the inverter anti-interference
	H1	COM Terminal	Consistent with the COM function on the terminal line .

Category	Symbol	Name	Function
		interface	

Signal input terminal circuit

Switch input and output signal transmission, generally use the shielded cable and wiring short distance as far as possible, good grounding and shielding layer on the inverter side, try not to over 20 m transmission distance. Drive in active way, elected to the power of crosstalk necessary filtering measures are taken, generally recommend that choose dry contact control mode.

Wiring control cable should be kept with the main circuit and high voltage lines (such as the power cord, motor connecting line, relay or contactor) more than 20 cm distance, and to avoid high voltage lines parallel to and can't be avoided and the high voltage lines cross, the proposal USES vertical wiring way, in order to prevent the misoperation caused by disturbance frequency converter

Dry contact mode:

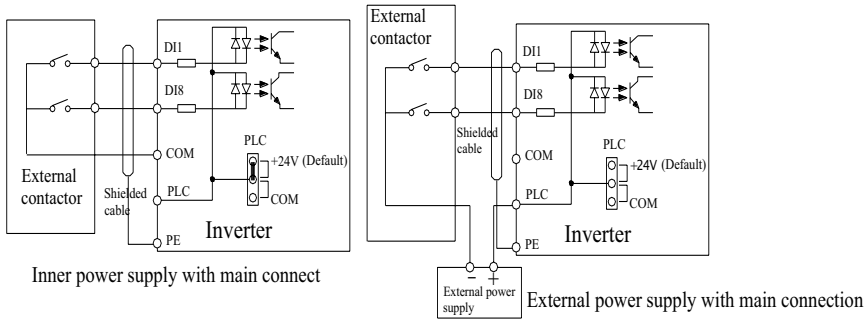
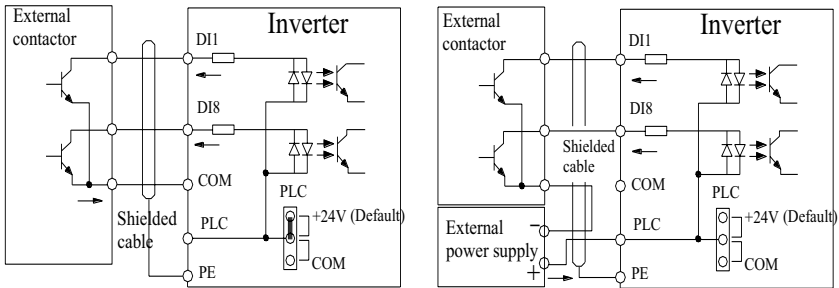

Diagram 4-14: signal input terminal circuit- dry contact mode

Note: using an external power supply, PLC and 24 v jumper cap must be removed, otherwise it will damage the product.

Open collector NPN connect wire:

When the input signal from the NPN transistor, according to the use of power supply, please according to the figure + 24 v and PLC jumper cap.



Inner power NPN connect mode

External power supply NPN connect mode

Signal input terminal wiring diagram, open collector NPN connection mode

Note: using an external power supply, PLC and 24 v jumper cap must be removed, otherwise it will damage the product.

Open collector PNP connection mode:

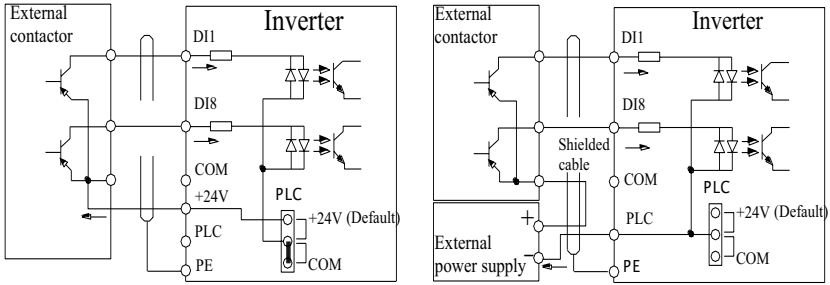

Inner power PNP connect mode

External power supply PNP connect mode

Diagram 4-15: Signal input terminal wiring diagram, open collector PNP connection mode

Note: using an external power supply, PLC and 24 v jumper cap must be removed, otherwise it will damage the product.

4-6. Wiring Precautions

⚠ Danger

Make sure that the power switch is in the OFF state before wiring operation, or electrical shock may occur!

Wiring must be performed by a professional trained personnel, or this may cause damage to the equipment and personal injury!

Must be grounded firmly, otherwise there is a danger of electric shock or fire hazard !

⚠ Note

Make sure that the input power is consistent with the rated value of inverter, otherwise which may cause damage to the inverter!

Make sure that the motor matches the inverter, otherwise which may cause damage to the motor or activate the inverter protection!

Do not connect power supply to U, V, W terminals, otherwise which may cause damage to the inverter!

Do not directly connect braking resistor to DC bus (P), (+) terminals, otherwise which may cause a fire!

- ※ The U, V, W output end of inverter can not install phase advancing capacitor or RC absorbing device. The inverter input power must be cut off when replacing the motor
- ※ Do not let metal chips or wire ends into inside the inverter when wiring, otherwise which may cause malfunction to the inverter.
- ※ Disconnect motor or switch power-frequency power supply only when the inverter stops output
- ※ In order to minimize the effects of electromagnetic interference, it is recommended that a surge absorption device shall be installed additionally when electromagnetic contactor and relay is closer from the inverter.
- ※ External control lines of inverter shall adopt isolation device or shielded wire.
- ※ In addition to shielding, the wiring of input command signal should also be aligned separately, it is best to stay away from the main circuit wiring.
- ※ If the carrier frequency is less than 3KHz, the maximum distance between the inverter and the motor should be within 50 meters; if the carrier frequency is greater than 4KHz, the distance should be reduced appropriately, it is best to lay the wiring inside metal tube.

- ※ When the inverter is additionally equipped with peripherals (filter, reactor, etc.), firstly measure its insulation resistance to ground by using 1000 volt megger, so as to ensure the measured value is no less than 4 megohms.
- ※ When the inverter need to be started frequently, do not directly turn power off, only the control terminal or keyboard or RS485 operation command can be used to control the start/stop operation, in order to avoid damage to the rectifier bridge.
- ※ To prevent the occurrence of an accident, the ground terminal(\perp) must be earthed firmly(grounding impedance should be less than 10 ohms), otherwise the leakage current will occur.
- ※ The specifications on wires used by the main circuit wiring shall comply with the relevant provisions of the National Electrical Code.
- ※ The motor's capacity should be equal to or less than the inverter's capacity.

4-7. Spare Circuit

When the inverter occurs the fault or trip, which will cause a larger loss of downtime or other unexpected faults. In order to avoid this case from happening, please additionally install spare circuit to ensure safety.

Note: Electrical diagram MCC1 and MCC2 interlock ac contactor; Spare circuit must be confirmed in advance and test running characteristics, make sure that the power frequency and frequency conversion phase sequence

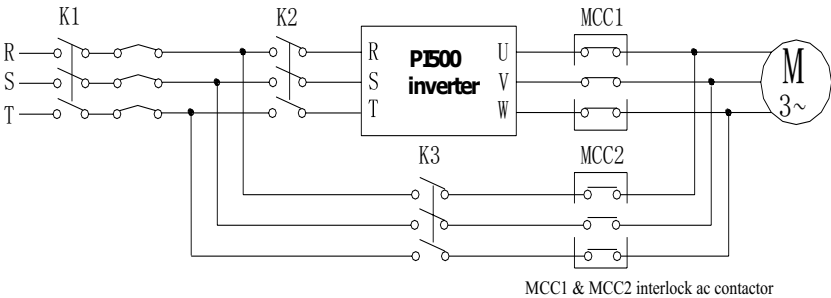

Diagram 4-16: Spare Circuit electrical diagram

4-8. Commissioning

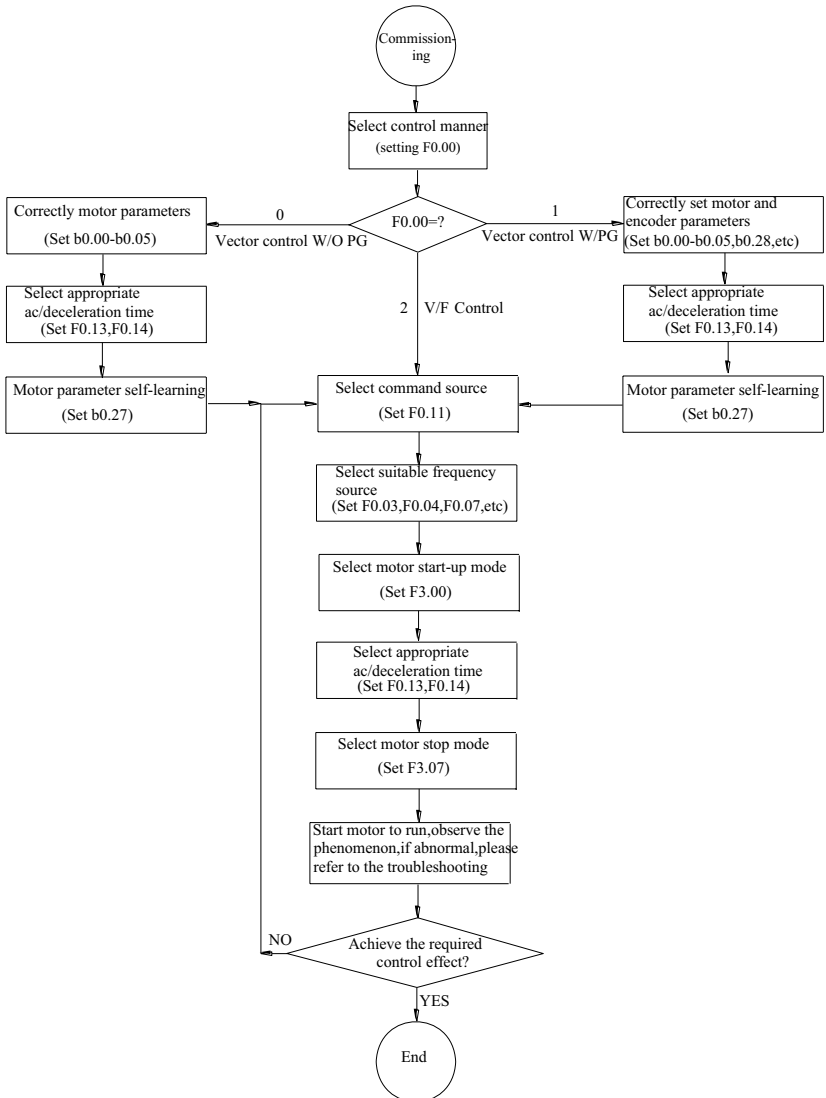

Diagram 4-17: Commissioning

- Firstly confirm that AC input power supply voltage shall be within inverter rated input voltage range before connecting power supply to the inverter.
- Connect power supply to the R, S and T terminals of the inverter.
- Select the appropriate operation control method.

Chapter 5 Function parameter

5-1. Menu grouping

Note:

“★”: In running status, can not modify the parameter setting

“●”: The actual testing data, can not be modified

“☆”: In stop and run statuses, both can be changed;

“▲”: “Factory parameter”, no change about it.

“_” means the factory parameter is related to power or model. Please check the details in the involved parameter introduction.

Note:“Italic ”means software version is C3.00 and the keyboard just like the above with MCU can do the functions.

Change limit refers to whether the parameters are adjustable.

y0.01 is used for parameters protection password. Parameter menu can be enter into only after inputting the right password in the function parameter mode or user change parameter mode. When the y0.01 set to 0, the password is canceled.

Parameter menu is not protected by password under user customized parameters mode.

F group is the basic function parameters,E group is to enhance function parameters, b group is a function of motor parameters,d group is the monitoring function parameters.

Code	Parameter name	Functional Description
d0	Monitoring function group	Monitoring frequency, current, etc
F0	Basic function group	Frequency setting, control mode, acceleration and deceleration time
F1	Input terminals group	Analog and digital input functions
F2	Output terminals group	Analog and digital output functions
F3	Start and stop control group	Start and stop control parameters
F4	V/F control parameters	V/F control parameters
F5	Vector control parameters	Vector control parameters
F6	Keyboard and display	To set key and display function parameters
F7	Auxiliary function group	To set Jog, jump frequency and other auxiliary function parameters
F8	Fault and protection	To set fault and protection parameters
F9	Communication parameter group	To set MODBUS communication function
FA	Torque control parameters	To set parameters under torque control mode
Fb	Control optimization parameters	To set parameters of optimizing the control performance
FC	Extend parameters group	specialapplicationparameterssetting
E0	Wobbulate, fixed-length and counting	To set Wobbulate, fixed-length and counting function parameters
E1	Multi-stage command, simple PLC	Multi-speed setting, PLC operation

E2	PID function group	To set Built-in PID parameters
E3	Virtual DI, Virtual DO	Virtual I/O parameter setting
b0	Motor parameters	To set motor parameter
y0	Function code management	To set password, parameter initialization and parameter group display
y1	Fault query	Fault message query

5-1-1. d0Group - Monitoring function group

No.	Code	Parameter name	Setting range	Factory setting
0.	d0.00	Running frequency	Actual output frequency	0.01Hz
1.	d0.01	Set frequency	Actual set frequency	0.01Hz
2.	d0.02	DC bus voltage	Detected value for DC bus voltage	0.1V
3.	d0.03	output voltage	Actual output voltage	1V
4.	d0.04	output current	Effective value for Actual motor current	0.01A
5.	d0.05	output power	Calculated value for motor output power	0.1kW
6.	d0.06	output torque	Motor output torque percentage	0.1%
7.	d0.07	DI input status	DI input status	-
8.	d0.08	DO output status	DO output status	-
9.	d0.09	AI1 voltage (V)	AI1 input voltage value	0.01V
10.	d0.10	AI2 voltage (V)	AI2 input voltage value	0.01V
11.	d0.11	AI3 voltage (V)	AI3 input voltage value	0.01V
12.	d0.12	Count value	Actual pulse count value in counting function	-
13.	d0.13	Length value	Actual length in fixed length function	-
14.	d0.14	Actual operating speed	Motor actual running speed	-
15.	d0.15	PID setting	Reference value percentage when PID runs	%
16.	d0.16	PID feedback	Feedback value percentage when PID runs	%
17.	d0.17	PLC stage	Stage display when PLC runs	-
18.	d0.18	High-speed pulse input frequency	High-speed pulse input frequency display, unit: 0.01Khz	0.01kHz
19.	d0.19	Feedback speed(unit:0.1Hz)	PG feedback speed, to an accuracy of 0.1hz	0.1Hz
20.	d0.20	Remaining run time	Remaining run time display, it is for timing run control	0.1Min

Chapter 5 Function parameter

21.	d0.21	Linear speed	Show the line speed of DI5 high speed pulse sampling, according to the actual sample pulse number per minute and E0.07, calculate the line speed value.	1m/Min
22.	d0.22	Current power-on time	Total time of current inverter power-on	Min
23.	d0.23	Current run time	Total time of current inverter run	0.1Min
24.	d0.24	HDI(DI5) impulse frequency	HDI(DI5) High-speed impulse input frequency display, unit: 1Hz	1Hz
25.	d0.25	Communication set value	Frequency, torque or other command values set by communication port	0.01%
26.	d0.26	Encoder feedback speed	PG feedback speed, to an accuracy of 0.01Hz	0.01Hz
27.	d0.27	Master frequency display	Frequency set by F0.03 master frequency setting source	0.01Hz
28.	d0.28	Auxiliary frequency display	Frequency set by F0.04 auxiliary frequency setting source	0.01Hz
29.	d0.29	Command torque (%)	Observe the set command torque under the torque control mode	0.1%
30.	d0.30	Reserve		
31.	d0.31	Synchro rotor position	Synchro rotor position angle	0.0°
32.	d0.32	Resolver position	Rotor position when rotary transformer is used as a speed feedback	-
33.	d0.33	ABZ position	Position information calculated from when ABZ incremental feedback encoder is adopted	0
34.	d0.34	Z signal counter	Encoder Z-phase signal count	-
35.	d0.35	Inverter status	Display run, standby and other statuses	-
36.	d0.36	Inverter type	1.G type (constant torque load type) 2.F type (fans/pumps load type)	-
37.	d0.37	AI1 voltage before correction	Input voltage value before AI1 linear correction	0.01V
38.	d0.38	AI2 voltage before correction	Input voltage value before AI2 linear correction	0.01V
39.	d0.39	AI3 voltage before correction	Input voltage value before AI3 linear correction	0.01V
40.	d0.40	Reserve		
41.	d0.41	motor temperature inspection function3	PT100 inspect motor temperature value	0℃

5-1-2. F0 Group -Basic function group

No.	Code	Parameter name	Setting range	Factory setting	Change
42.	F0.00	Motor control manner	0.Vector control W/O PG 1.Vector control W/ PG 2.V/F control	2	★
43.	F0.01	Keyboard set frequency	0.00Hz to F0.19 (maximum frequency)	50.00Hz	☆
44.	F0.02	Frequency command resolution	1: 0.1Hz; 2: 0.01Hz	2	★
45.	F0.03	Frequency source master setting	0 to 10	0	★
46.	F0.04	Frequency source auxiliary setting	0 to 10	0	★
47.	F0.05	Reference object selection for frequency source auxiliary setting	0. relative to maximum frequency 1.relative to master frequency source 1 2. relative to master frequency source 2	0	☆
48.	F0.06	Frequency source auxiliary setting range	0% to 150%	100%	☆
49.	F0.07	Frequency source superimposed selection	Units digit: frequency source selection Tens digit: arithmetic relationship of master and auxiliary for frequency source	00	☆
50.	F0.08	Frequency source offset frequency when superimposing	0.00Hz to F0.19(maximum frequency)	0.00Hz	☆
51.	F0.09	Shutdown memory selection for digital set frequency	0: W/O memory 1: With memory	1	☆
52.	F0.10	Frequency command UP / DOWN reference when running	0: Running frequency 1: Set frequency	0	★
53.	F0.11	Command source selection	0.Keyboard control (LED off) 1.Terminal block control (LED on) 2.Communications command control (LED flashes) 3. Keyboard control+ Communications command control 4. Keyboard control+ Communications command control+ Terminal block control	0	☆

Chapter 5 Function parameter

54.	F0.12	Binding frequency source for command source	Units digit: binding frequency source selection for operation panel command Tens digit: terminal command binding frequency source selection (0 to 9, same as units digit) Hundreds digit: communication command binding frequency source selection (0 to 9, same as units digit)	000	☆
55.	F0.13	Acceleration time 1	0.00s to 6500s	Depends on models	☆
56.	F0.14	Deceleration time 1	0.00s to 6500s	Depends on models	☆
57.	F0.15	Ac/Deceleration time unit	0:1 second; 1:0.1 second; 2:0.01 second	1	★
58.	F0.16	Ac/deceleration time reference frequency	0: F0.19(maximum frequency) 1: Set frequency 2: 100Hz	0	★
59.	F0.17	Carrier frequency adjustment as per temperature	0: NO; 1: YES	0	☆
60.	F0.18	Carrier Frequency	0.5kHz to 16.0kHz	Depends on models	☆
61.	F0.19	Maximum output frequency	50.00Hz to 320.00Hz	50.00Hz	★
62.	F0.20	Upper limit frequency source	0: F0.21 setting 1: AI1 analog quantity setting 2: AI2 analog quantity setting 3: Panel potentiometer setting 4: High-speed pulse setting 5: communications reference 6: AI3 analog quantity setting	0	★
63.	F0.21	Upper limit frequency	F0.23 (lower limit frequency) to F0.19(maximum frequency)	50.00Hz	☆
64.	F0.22	Upper limit frequency offset	0.00Hz to F0.19 (maximum frequency)	0.00Hz	☆
65.	F0.23	Lower limit frequency	0.00Hz to F0.21 (upper limit frequency)	0.00Hz	☆
66.	F0.24	Running direction	0:same direction 1: opposite direction	0	☆
67.	F0.25	Reserve			
68.	F0.26	Reserve			
69.	F0.27	GF type	1.G type (constant torque load type) 2.F type (fans/pumps load type)	-	●

5-1-3. F1 Group - Input terminals group

No.	Code	Parameter name	Setting range	Factory setting	Change
70.	F1.00	DI1 terminal function selection	0 to 51	1	★
71.	F1.01	DI2 terminal function selection		2	★
72.	F1.02	DI3 terminal function selection		0	★
73.	F1.03	DI4 terminal function selection		9	★
74.	F1.04	DI5 terminal function selection		12	★
75.	F1.05	DI6 terminal function selection		13	★
76.	F1.06	DI7 terminal function selection		0	★
77.	F1.07	DI8 terminal function selection		0	★
78.	F1.08	Undefined			
79.	F1.09	Undefined			
80.	F1.10	Terminal command mode	0: Two-wire type 1 1: Two-wire type 2 2: Three-wire type 1 3: Three-wire type 2	0	★
81.	F1.11	Terminal UP/DOWN change rate	0.001Hz/s to 65.535Hz/s	1.000Hz/s	☆
82.	F1.12	Minimum input for AIC1	0.00V to F1.14	0.00V	☆
83.	F1.13	F1.12corresponding setting	-100.00% to +100.0%	0.0%	☆
84.	F1.14	Maximum input for AIC1	F1.12 to +10.00V	10.00V	☆
85.	F1.15	F1.14corresponding setting	-100.00% to +100.0%	100.0%	☆
86.	F1.16	Minimum input for AIC2	0.00V to F1.18	0.00V	☆
87.	F1.17	F1.16corresponding setting	-100.00% to +100.0%	0.0%	☆
88.	F1.18	Maximum input for AIC2	F1.16 to +10.00V	10.00V	☆
89.	F1.19	F1.18corresponding setting	-100.00% to +100.0%	100.0%	☆
90.	F1.20	Minimum input for AIC3	-10.00V to F1.22	0.00V	☆
91.	F1.21	F1.20corresponding setting	-100.00% to +100.0%	0.0%	☆
92.	F1.22	Maximum input for AIC 3	F1.20 to +10.00V	10.00V	☆
93.	F1.23	F1.22corresponding setting	-100.00% to +100.0%	100.0%	☆
94.	F1.24	AICurve selection	Units digit: All curve selection Tens digit: A12 curve selection Hundreds digit:panel potentiometer curve selection	321	☆

Chapter 5 Function parameter

95.	F1.25	Setting selection for AI input	Units digit: setting selection for AI1 less than minimum input 0: corresponding to minimum setting 1: 0.0% Tens digit: setting selection for AI2 less than minimum input, ditto Hundreds digit: setting selection for AI3 less than minimum input(0 to 1,ditto)	000	☆
96.	F1.26	HDI Minimum pulse input	0.00kHz to F1.28	0.00kHz	☆
97.	F1.27	F1.26 corresponding setting	-100.00% to +100.0%	0.0%	☆
98.	F1.28	HDI Maximum input	F1.26 to 100.00kHz	50.00kHz	☆
99.	F1.29	F1.28 corresponding setting	-100.00% to +100.0%	100.0%	☆
100.	F1.30	DI filter time	0.000s to 1.000s	0.010s	☆
101.	F1.31	AI1 filter time	0.00s to 10.00s	0.10s	☆
102.	F1.32	AI2 filter time	0.00s to 10.00s	0.10s	☆
103.	F1.33	AI3 filter time	0.00s to 10.00s	0.10s	☆
104.	F1.34	HDI Filter time	0.00s to 10.00s	0.00s	☆
105.	F1.35	DI terminal valid mode selection 1	Units digit: DI1 0: high level active 1: low level active Tens digit: DI2 Hundreds digit: DI3 Thousands digit: DI4 Ten thousands digit: DI5	00000	★
106.	F1.36	DI terminal valid mode selection 2	Units digit: DI6 0: high level active 1: low level active Tens digit: DI7 Hundreds digit: DI8 Thousands digit: DI9 Ten thousands digit: DI10	00000	★
107.	F1.37	DI1 delay time	0.0s to 3600.0s	0.0s	★
108.	F1.38	DI2 delay time	0.0s to 3600.0s	0.0s	★
109.	F1.39	DI3 delay time	0.0s to 3600.0s	0.0s	★
110.	F1.40	Define the input terminal repeat	0:unrepeatable 1:repeatable	0	★
111.	F1.41	Keyboard potentiometer X1	0~100.00%	0.00%	☆
112.	F1.42	Keyboard potentiometer X2	0~100.00%	100.00%	☆
113.	F1.43	Keyboard potentiometer set value	0~100.00%	-	☆

114.	F1.44	Keyboard potentiometer X1 corresponding value Y1	-100.00%~+100.00%	0.00%	☆
115.	F1.45	Keyboard potentiometer X2 corresponding valueY2	-100.00%~+100.00%	100.00%	☆
116.	F1.46	Keyboard potentiometer control	Bits: 0: Power down protection 1: Power down zero clear Ten bits: 0: Stop keep 1: Stop order zero clear 2: Stop over zero clear Hundred bits: reserve Thousand bits: reserve	00	☆

5-1-4. F2 Group - Output terminals group

No	Code	Parameter name	Setting range	Factory setting	Change
117.	F2.00	SPB terminal output mode selection	0 to 1	0	☆
118.	F2.01	Switching quantity output function selection	0 to 40	0	☆
119.	F2.02	Relay 1 output function selection (TA1.TB1.TC1)		2	☆
120.	F2.03	Undefined			
121.	F2.04	SPA output function selection (collector open circuit output terminals)		1	☆
122.	F2.05	Relay 2 output function selection (TA2.TB2.TC2)		1	☆
123.	F2.06	High-speed pulse output function selection		0 to 17	0
124.	F2.07	DA1 output function selection	0		☆
125.	F2.08	DA2 output function selection	1		☆
126.	F2.09	Maximum output frequency of high-speed pulse	0.01kHzto 100.00kHz	50.00kHz	☆
127.	F2.10	SPB switching quantity output delay time	0.0s to 3600.0s	0.0s	☆
128.	F2.11	Relay 1 output delay time	0.0s to 3600.0s	0.0s	☆
129.	F2.12	Expansion card DO output delay time	0.0s to 3600.0s	0.0s	☆
130.	F2.13	SPA output delay time	0.0s to 3600.0s	0.0s	☆
131.	F2.14	Relay 2 output delay time	0.0s to 3600.0s	0.0s	☆

132.	F2.15	DO output terminal active status selection	Units digit: SPB switching quantity 0: positive logic 1: anti-logic Tens digit: Relay 1 Hundreds digit: Hundreds digit: Undefined Thousands digit: SPA Ten thousands digit: Relay 2	00000	☆
133.	F2.16	DA1 zero bias coefficient	-100.0% to +100.0%	0.0%	☆
134.	F2.17	DA1 gain	-10.00 to +10.00	1.00	☆
135.	F2.18	DA2 zero bias coefficient	-100.0% to +100.0%	0.00%	☆
136.	F2.19	DA2 gain	-10.00 to +10.00	1.00	☆

5-1-5. F3 Group - Start and stop control group

No.	Code	Parameter name	Setting range	Factory setting	Change
137.	F3.00	Start-up mode	0: Direct startup 1: Speed tracking restart 2: Pre-excitation start (AC asynchronous motor)	0	☆
138.	F3.01	Speed tracking mode	0~2: reserve 3: Rotate speed tracking method3	3	★
139.	F3.02	Speed tracking value	1 to 100	20	☆
140.	F3.03	Start frequency	0.00Hz to 10.00Hz	0.00Hz	☆
141.	F3.04	Hold time for start frequency	0.0s to 100.0s	0.0s	★
142.	F3.05	DC beforehand field current	0% to 100%	0%	★
143.	F3.06	DC excitation time beforehand	0.0s to 100.0s	0.0s	★
144.	F3.07	Stop mode	0: Deceleration parking 1: Free stop	0	☆
145.	F3.08	DC Initial frequency	0.00Hz to F0.19 (maximum frequency)	0.00 Hz	☆
146.	F3.09	DC Waiting time	0.0s to 100.0s	0.0s	☆
147.	F3.10	Stop DC braking current	0% to 100%	0%	☆
148.	F3.11	Stop DC braking time	0.0s to 100.0s	0.0s	☆
149.	F3.12	Braking utilization rate	0% to 100%	100%	☆

150.	F3.13	Ac/deceleration mode	0: Linear acceleration and deceleration 1:S curve acceleration and deceleration A 2:S curve acceleration and deceleration B	0	★
151.	F3.14	Proportion of S curve start-section	0.0% to (100.0%to F3.15)	30.0%	★
152.	F3.15	Proportion of S curve end-section	0.0% to (100.0% to F3.14)	30.0%	★

5-1-6. F4 Group - V/F control parameters

No.	Code	Parameter name	Setting range	Factory setting	Change
153.	F4.00	V/F curve setting	0 to 1	0	★
154.	F4.01	Torque boost	0.0%(Automatic torque boost)0.1 to 30%	-	★
155.	F4.02	Torque boost cut-off frequency	0.00Hz to F0.19(maximum frequency)	15.00 Hz	★
156.	F4.03	Multipoint V/F frequency point 1	0.00Hz to F4.05	0.00Hz	★
157.	F4.04	Multipoint V/F voltage point 1	0.0% to 100.0%	0.0%	★
158.	F4.05	Multipoint V/F frequency point 2	F4.03 to F4.07	0.00Hz	★
159.	F4.06	Multipoint V/F voltage point 2	0.0% to 100.0%	0.0%	★
160.	F4.07	Multipoint V/F frequency point 3	F4.05 to b0.04 (rated motor frequency)	0.00Hz	★
161.	F4.08	Multipoint V/F voltage point 3	0.0% to 100.0%	0.0%	★
162.	F4.09	Slip compensation coefficient	0% to 200.0%	0.0%	☆
163.	F4.10	Overexcitation gain	0 to 200	64	☆
164.	F4.11	Oscillation suppression gain	0 to 100	0	☆
165.	F4.12	V/F separation voltage source	0 to 9	0	☆
166.	F4.13	V/F separation voltage digital setting	0V to rated motor voltage	0V	☆
167.	F4.14	V/F separation voltage rise time	0.0s to 1000.0s	0.0s	☆

5-1-7. F5 Group - Vector control parameters

No.	Code	Parameter name	Setting range	Factory setting	Change
168.	F5.00	Speed loop ratio G1	1 to 100	30	☆
169.	F5.01	Speed loop integral T1	0.01s to 10.00s	0.50s	☆
170.	F5.02	switching frequency 1	0.00 to F5.05	5.00Hz	☆
171.	F5.03	Speed loop ratio G2	0 to 100	20	☆

Chapter 5 Function parameter

172.	F5.04	Speed loop integral T2	0.01s to 10.00s	1.00s	☆
173.	F5.05	switching frequency 2	F5.02 to F0.19 (max. frequency)	10.00 Hz	☆
174.	F5.06	Speed loop integral	0:valid 1:invalid	0	☆
175.	F5.07	Torque limit upper limit source	0'8	0	☆
176.	F5.08	Upper limit digital setting for torque	0.0% to 200.0%	150.0%	☆
177.	F5.09	Vector control differential gain	50% to 200%	150%	☆
178.	F5.10	Speed loop filter time constant	0.000s to 0.100s	0.000s	☆
179.	F5.11	Vector control overexcitation gain	0 to 200	64	☆
180.	F5.12	Excitation regulator proportional gain	0 to 60000	2000	☆
181.	F5.13	Excitation regulator integral gain	0 to 60000	1300	☆
182.	F5.14	Torque regulator proportional gain	0 to 60000	2000	☆
183.	F5.15	Torque regulator integral gain	0 to 60000	1300	☆

5-1-8. F6 Group - Keyboard and display

No.	Code	Parameter name	Setting range	Factory setting	Change
184.	F6.00	STOP/RESET key functions	0: STOP/RES key is enabled only under keyboard operation mode 1:STOP/RES key is enabled under any operation mode	1	☆
185.	F6.01	Running status display parameters 1	0x0000 to 0xFFFF	001F	☆
186.	F6.02	Running status display parameters 2	0x0000 to 0xFFFF	0000	☆
187.	F6.03	Stop status display parameters	0x0000 to 0xFFFF	0033	☆
188.	F6.04	Load speed display coefficient	0.0001 to 6.5000	3.0000	☆
189.	F6.05	Decimal places for load speed display	0:0 decimal places 2:2 decimal places 1:1 decimal places 3:3 decimal places	1	●
190.	F6.06	Inverter module radiator temperature	0.0℃ to 100.0℃	-	●
191.	F6.07	Total run time	0h to 65535h	-	●
192.	F6.08	Total power-on time	0h to 65535h	-	●
193.	F6.09	Total power consumption	0 to 65535 kwh	-	●
194.	F6.10	Product series number	Frequency inverter series number	-	●

195.	F6.11	Software version number	Control board software version	-	●	
196.	F6.12~ F6.15	Reserve				
197.	F6.16	Monitor selection 2	1Kbit/100bit	10bit/1bit	d0.04	●
			parameter number	parameter series number		
198.	F6.17	Power correction coefficient	0.00~10.00	1.00	☆	
199.	F6.18	Multifunction key definition 1	0 to 7	0	☆	
200.	F6.19	Multifunction key definition 2	0 to 7	0	☆	
201.	F6.20	Keypad lock selection	0:RUN, STOP button valid 1:RUN, STOP, keypad encode valid 2: RUN, STOP, UP, DOWN button valid 3: STOP button valid	0	☆	
202.	F6.21	QUICK key function selection	0: no function 1: Jog running 2: Shift switch display state 3: FWD/RVS switchover 4: Clear-up UP/DOWN setting 5: Free stop 6: running command given in sequence	1	☆	

5-1-9. F7 Auxiliary function group

No.	Code	Parameter name	Setting range	Factory setting	Charge
203.	F7.00	Jog running frequency	0.00Hz to F0.19(maximum frequency)	2.00Hz	☆
204.	F7.01	Jog acceleration time	0.0s to 6500.0s	20.0s	☆
205.	F7.02	Jog deceleration time	0.0s to 6500.0s	20.0s	☆
206.	F7.03	Jog priority	0:Invalid 1: Valid	0	☆
207.	F7.04	Jump frequency 1	0.00Hz to F0.19 (maximum frequency)	0.00Hz	☆
208.	F7.05	Jump frequency 2	0.00Hz to F0.19(maximum frequency)	0.00Hz	☆
209.	F7.06	Jump frequency range	0.00Hz to F0.19 (maximum frequency)	0.00Hz	☆
210.	F7.07	Jump frequency availability during ac/deceleration process	0: Invalid 1: Valid	0	☆
211.	F7.08	Acceleration time 2	0.0s to 6500.0s	Depends on models	☆
212.	F7.09	Deceleration time 2	0.0s to 6500.0s	Depends on models	☆

Chapter 5 Function parameter

213.	F7.10	Acceleration time 3	0.0s to 6500.0s	Depends on models	☆
214.	F7.11	Deceleration time 3	0.0s to 6500.0s	Depends on models	☆
215.	F7.12	Acceleration time 4	0.0s to 6500.0s	Depends on models	☆
216.	F7.13	Deceleration time 4	0.0s to 6500.0s	Depends on models	☆
217.	F7.14	Switching frequency point between acceleration time 1 and acceleration time 2	0.00Hz to F0.19 (maximum frequency)	0.00Hz	☆
218.	F7.15	Switching frequency point between deceleration time 1 and deceleration time 2	0.00Hz to F0.19 (maximum frequency)	0.00Hz	☆
219.	F7.16	Forward/reverse rotation deadband	0.00s to 3600.0s	0.00s	☆
220.	F7.17	Reverse rotation control	0: Enable 1: Disable	0	☆
221.	F7.18	Set frequency lower than lower limit frequency mode	0: running at lower limit frequency 1: stop 2: zero speed running	0	☆
222.	F7.19	Droop control	0.00Hz to 10.00Hz	0.00Hz	☆
223.	F7.20	Setting cumulative power-on arrival time	0h to 36000h	0h	☆
224.	F7.21	Setting cumulative running arrival time	0h to 36000h	0h	☆
225.	F7.22	Start protection selection	0: OFF 1: ON	0	☆
226.	F7.23	Frequency detection value (FDT1)	0.00Hz to F0.19(maximum frequency)	50.00Hz	☆
227.	F7.24	Frequency detection hysteresis value (FDT1)	0.0% to 100.0% (FDT1 level)	5.0%	☆
228.	F7.25	Frequency reaches detection width	0.00 to 100% (maximum frequency)	0.0%	☆
229.	F7.26	Frequency detection value (FDT2)	0.00Hz to F0.19 (maximum frequency)	50.00Hz	☆
230.	F7.27	Frequency detection hysteresis value (FDT2)	0.0% to 100.0% (FDT2 level)	5.0%	☆
231.	F7.28	Random arrivals frequency detection value 1	0.00Hz to F0.19 (maximum frequency)	50.00Hz	☆
232.	F7.29	Random arrivals frequency detection width 1	0.00% to 100.0% (maximum frequency)	0.0%	☆

233.	F7.30	Random arrivals frequency detection value 2	0.00Hz to F0.19 (maximum frequency)	50.00Hz	☆
234.	F7.31	Random arrivals frequency detection width 2	0.00% to 100.0% (maximum frequency)	0.0%	☆
235.	F7.32	Zero current detection level	0.0% to 300.0% (rated motor current)	5.0%	☆
236.	F7.33	Zero current detection delay time	0.01s to 360.00s	0.10s	☆
237.	F7.34	Overrun value of output current	0.0% (not detected) 0.1% to 300.0% (rated motor current)	200.0%	☆
238.	F7.35	Output current overrun detection delay time	0.00s to 360.00s	0.00s	☆
239.	F7.36	Random arrivals current 1	0.0% to 300.0% (rated motor current)	100%	☆
240.	F7.37	Random arrivals current 1 width	0.0% to 300.0% (rated motor current)	0.0%	☆
241.	F7.38	Random arrivals current 2	0.0% to 300.0% (rated motor current)	100%	☆
242.	F7.39	Random arrivals current 2 width	0.0% to 300.0% (rated motor current)	0.0%	☆
243.	F7.40	Module temperature arrival	0℃ to 100℃	75℃	☆
244.	F7.41	Cooling fan control	0: Fan running only when running 1: Fan always running	0	☆
245.	F7.42	Timing function selection	0: Invalid 1: Valid	0	★
246.	F7.43	Timing run time selection	0: F7.44 setting 1: AI1 2: AI2 3: Panel potentiometer Analog input range corresponds to F7.44	0	★
247.	F7.44	Timing run time	0.0Min to 6500.0Min	0.0Min	★
248.	F7.45	Current running reaches the set time.	0.0Min to 6500.0Min	0.0Min	★
249.	F7.46	Awakens frequency	dormancy frequency (F7.48) to maximum frequency (F0.19)	0.00Hz	☆
250.	F7.47	Awakens delay time	0.0s to 6500.0s	0.0s	☆
251.	F7.48	Dormancy frequency	0.00Hz to awakens frequency(F7.46)	0.00Hz	☆
252.	F7.49	Dormancy delay time	0.0s to 6500.0s	0.0s	☆
253.	F7.50	All input voltage protection lower limit	0.00V to F7.51	3.1V	☆
254.	F7.51	All input voltage protection upper limit	F7.50 to 10.00V	6.8V	☆

255.	F7.52~ F7.53	Reserve			
256.	F7.54	Jog mode setting ³	<p>Bits:</p> <p>0: forward 1: reverse 2: determine the direction from the main termina</p> <p>Ten bits:</p> <p>0: restore to the previous state after jogging 1: stop running after jogging</p> <p>Hundred bits:</p> <p>0:recover to the previous deceleration time after jogging 1: keep the deceleration time the sameafter jogging</p>	002	☆

5-1-10. F8 Group - Fault and protection

No.	Code	Parameter name	Setting range	Factory setting	Change
257.	F8.00	Overcurrent stall gain	0 to 100	20	☆
258.	F8.01	Overcurrent stall protection current	100% to 200%	150%	☆
259.	F8.02	Motor overload protection selection	0: Invalid 1: Enable	1	☆
260.	F8.03	Motor overload protection gain	0.20 to 10.00	1.00	☆
261.	F8.04	Motor overload pre-alarm coefficient	50% to 100%	80%	☆
262.	F8.05	Over-voltage stall gain	0 to 100	0	☆
263.	F8.06	Over-voltage stall protection voltage / energy consumption brake voltage	120% to 150%	130%	☆
264.	F8.07	Input phase loss protection selection	<p>Units digit:Input phase loss protection selection 0: Invalid 1: Enable Tens digit:contactor actuation protection 0: Invalid 1: Enable</p>	11	☆
265.	F8.08	Output phase loss protection selection	0: Invalid 1: Enable	1	☆
266.	F8.09	Short to ground protection	0:Invalid 1: Valid	1	☆
267.	F8.10	Number of automatic fault reset	0 to 32767	0	☆
268.	F8.11	Fault DO action selection during	0: OFF	0	☆

		automatic fault reset	1: ON		
269.	F8.12	Automatic fault reset interval	0.1s to 100.0s	1.0s	☆
270.	F8.13	Over-speed detection value	0.0 to 50.0% (maximum frequency)	20.0%	☆
271.	F8.14	Over-speed detection time	0.0 to 60.0s	1.0s	☆
272.	F8.15	Detection value for too large speed deviation	0.0 to 50.0% (maximum frequency)	20.0%	☆
273.	F8.16	Detection time for too large speed deviation	0.0 to 60.0s	5.0s	☆
274.	F8.17	Fault protection action selection 1	Units digit: Motor overload (Err.11) 0: Free stop 1: Stop at the selected mode 2: Continue to run Tens digit: input phase loss (Err.12) (same as units digit) Hundred digit: output phase loss (Err.13) (same as units digit) Thousand digit: external fault (Err.15) (same as units digit) Ten thousands digit: Communication abnormal(Err.16)(same as units digit)	00000	☆
275.	F8.18	Fault protection action selection 2	Units digit: Encoder fault(Err.20) 0: Free stop 1:Switch to V/F and then stop at the selected mode 2:Switch to V/F and continue to run Tens digit: function code read and write abnormal (Err.21) 0: Free stop 1: Stop at the selected mode Hundreds digit: Reserved Thousands digit: Motor overheating (Err.45) (same as F8.17 units digit) Ten thousands digit: Running time arrival(Err.26)(same as	00000	☆

			F8.17 units digit)		
276.	F8.19	Fault protection action selection 3	Units digit: User-defined fault 1 (Err.27) (same as F8.17 units digit) Tens digit: User-defined fault 2 (Err.28) (same as F8.17 units digit) Hundreds digit: Power-on time arrival (Err.29) (same as F8.17 units digit) Thousands digit: Load drop (Err.30) 0: Free stop 1: stop at select mode 2: Deceleration to 7% of the rated motor frequency and then continue running, automatically return to the set frequency to run if the load drop does not happen. automatically return to the set frequency to run if the load drop does not happen. automatically restore to the set frequency for when the load drop does not happen. Ten thousands digit: PID feedback loss when running (Err.31) (same as F8.17 units digit)	00000	☆
277.	F8.20	Fault protection action selection 4	Units digit: Too large speed deviation (Err.42) (same as F8.17 units digit) Tens digit: Motor over-speed (Err.43) Hundreds digit: Initial position error (Err.51) (same as F8.17 units digit) Thousands digit: Reserved Ten thousands digit: Reserved	00000	☆
278.	F8.21~ F8.23	Reserve			
279.	F8.24	Fault running frequency	0: current frequency running 1: setting frequency running 2: upper frequency	0	☆

			running 3: down frequency running 4: Abnormal reserve frequency running		
280.	F8.25	Abnormal reserve frequency	60.0% to 100.0%	90%	☆
281.	F8.26	Momentary power cut action selection	0: Invalid 1: Deceleration 2: Deceleration and stop	0.50s	☆
282.	F8.27	Frequency switching points for momentary power cut deceleration	50.0% to 100.0%	80%	☆
283.	F8.28	Recovery voltage judgment time of momentary power cut	0.00s to 100.00s	0	☆
284.	F8.29	Judgment voltage of momentary power cut action	50.0% to 100.0% (standard bus voltage)	10%	☆
285.	F8.30	Load drop protection selection	0: Invalid 1: Valid	1.0s	☆
286.	F8.31	load drop detection level	0.0 to 100.0%	0	☆
287.	F8.32	Load drop detection time	0.0 to 60.0s	110	☆
288.	F8.33	motor temperature sensor type	0: Invalid;1: PT100 detect	90	☆
289.	F8.34	motor over heat protection value	0~200	110	☆
290.	F8.35	motor over heat alma value	0~200	90	☆

5-1-11. F9 Group - Communication parameter

No.	Code	Parameter name	Setting range	Factory setting	Change
291.	F9.00	Baud rate	Units digit:MODBUS Tens digit:Profibus-DP Hundreds digit:Reserve Thousands digit:CAN bus baudrate	6005	☆
292.	F9.01	Data format	0: no parity (8-N-2) 1: even parity (8-E-1) 2: odd parity (8-O-1) 3: no parity (8-N-1)	0	☆
293.	F9.02	This unit address	1-250, 0 for broadcast address	1	☆
294.	F9.03	Response delay	0ms-20ms	2ms	☆
295.	F9.04	Communication timeout time	0.0 (Invalid); 0.1~60.0s	0.0	☆

296.	F9.05	Data protocol selection	Units digit: MODBUS 0: non-standard MODBUS protocol 1: standard MODBUS protocol Tens digit: Profibus-DP 0: PP01 format 1: PP02 format 2: PP03 format 3: PP05 format	30	☆
297.	F9.06	Current resolution	0: 0.01A 1: 0.1A	0	☆
298.	F9.07	Baud rate	Units digit:MODBUS Tens digit:Profibus-DP Hundreds digit:Reserve Thousands digit:CAN bus baudrate	6005	☆

5-1-12. FA Group - Torque control parameters

No.	Code	Parameter name	Setting range	Factory setting	Change
299.	FA.00	Speed/torque control mode selection	0: speed control 1: torque control	0	★
300.	FA.01	Torque setting source selection under torque control mode	0: keyboard setting (FA.02) 1: Analog AI1 setting 2: Analog AI2 setting 3: Panel potentiometer setting 4: High-speed pulse setting 5: Communications reference 6: MIN (AI1, AI2) 7: MAX (AI1, AI2) 8. High-speed pulse setting	0	★
301.	FA.02	Torque figures set under torque control mode	-200.0% to 200.0%	150%	☆
302.	FA.03	Torque control acceleration time	0.00s to 650.00s	0.00s	☆
303.	FA.04	Torque control deceleration time	0.00s to 650.00s	0.00s	☆
304.	FA.05	Torque control forward maximum frequency	0.00Hz to F0.19(maximum frequency)	50.00 Hz	☆
305.	FA.06	Torque control backward maximum frequency	0.00Hz to F0.19 (maximum frequency)	50.00 Hz	☆
306.	FA.07	Torque filter time	0.00s to 10.00s	0.00s	☆

5-1-13. FB Group - Control optimization parameters

No.	Code	Parameter name	Setting range	Factory setting	Change
307.	FB.00	Fast current limiting manner	0: Invalid 1: enable	1	☆
308.	FB.01	Under-voltage point setting	50.0% to 140.0%	100.0%	☆

309.	FB.02	Over-voltage point setting	200.0V to 2500.0V	810V	☆
310.	FB.03	Deadband compensation mode selection	0: no compensation 1: compensation mode 1 2: compensation mode 2	1	☆
311.	FB.04	Current detection compensation	0 to 100	5	☆
312.	FB.05	Vector optimization without PG mode selection	0: no optimization 1: optimization mode 1 2: optimization mode 2	1	☆
313.	FB.06	Upper limiting frequency for DPWM switching	0.00Hz to 15.00Hz	12.00 Hz	☆
314.	FB.07	PWM modulation manner	0:asynchronous; 1:synchronous	0	☆
315.	FB.08	Random PWM depth	0: Invalid 1 to 10: PWM carrier frequency random depth	0	☆
316.	FB.09	Deadband time adjustment	100% to 200%	150%	☆

5-1-14. FC Group - Extended parameter group

No.	Code	Parameter name	Setting range	Factory setting	Change
317.	FC.00	Undefined			
318.	FC.01	Proportional linkage coefficient	0.00 to 10.00	0	☆
319.	FC.02	PIDstart deviation	0.0 to 100.0	0	☆

5-1-15. E0 Group - Wobble, fixed-length and counting

No.	Code	Parameter name	Setting range	Factory setting	Change
320.	E0.00	Swing setting manner	0: relative to center frequency 1: relative to maximum frequency	0	☆
321.	E0.01	Wobble range	0.0% to 100.0%	0.0%	☆
322.	E0.02	Sudden jump frequency range	0.0% to 50.0%	0.0%	☆
323.	E0.03	Wobble cycle	0.1s to 3000.0s	10.0s	☆
324.	E0.04	Triangle wave rise time coefficient	0.1% to 100.0%	50.0%	☆
325.	E0.05	Set length	0m to 65535m	1000m	☆
326.	E0.06	Actual length	0m to 65535m	0m	☆
327.	E0.07	Pulse per meter	0.1 to 6553.5	100.0	☆
328.	E0.08	Set count value	1 to 65535	1000	☆

329.	E0.09	Specified count value	1 to 65535	1000	☆
330.	E0.10	Reduction frequency pulse number	0: invalid; 1~65535	0	☆
331.	E0.11	Reduction frequency	0.00Hz~F0.19(max frequency)	5.00Hz	☆

5-1-16. E1 Group, Multi-speed, Simple PLC

No.	Code	Parameter name	Setting range	Factory setting	Change
332.	E1.00	0-stage speed setting 0X	-100.0% to 100.0%	0.0%	☆
333.	E1.01	1-stage speed setting 1X	-100.0% to 100.0%	0.0%	☆
334.	E1.02	2-stage speed setting 2X	-100.0% to 100.0%	0.0%	☆
335.	E1.03	3-stage speed setting 3X	-100.0% to 100.0%	0.0%	☆
336.	E1.04	4-stage speed setting 4X	-100.0% to 100.0%	0.0%	☆
337.	E1.05	5-stage speed setting 5X	-100.0% to 100.0%	0.0%	☆
338.	E1.06	6-stage speed setting 6X	-100.0% to 100.0%	0.0%	☆
339.	E1.07	7-stage speed setting 7X	-100.0% to 100.0%	0.0%	☆
340.	E1.08	8-stage speed setting 8X	-100.0% to 100.0%	0.0%	☆
341.	E1.09	9-stage speed setting 9X	-100.0% to 100.0%	0.0%	☆
342.	E1.10	10-stage speed setting 10X	-100.0% to 100.0%	0.0%	☆
343.	E1.11	11-stage speed setting 11X	-100.0% to 100.0%	0.0%	☆
344.	E1.12	12-stage speed setting 12X	-100.0% to 100.0%	0.0%	☆
345.	E1.13	13-stage speed setting 13X	-100.0% to 100.0%	0.0%	☆
346.	E1.14	14-stage speed setting 14X	-100.0% to 100.0%	0.0%	☆
347.	E1.15	15-stage speed setting 15X	-100.0% to 100.0%	0.0%	☆
348.	E1.16	Simple PLC running mode	0: stop after single running 1: hold final value after single running 2: circulating	0	☆
349.	E1.17	Simple PLC power-down memory selection	Units digit: power-down memory selection 0: power-down without memory 1: power-down with memory Tens digit: stop memory selection 0: stop without memory 1: stop with memory	00	☆
350.	E1.18	0 stage running time T0	0.0s(h) to 6500.0s(h)	0.0s(h)	☆

351.	E1.19	0 stage ac/deceleration time selection	0 to 3	0	☆
352.	E1.20	1 stage running time T1	0.0s(h) to 6500.0s(h)	0.0s(h)	☆
353.	E1.21	1 stage ac/deceleration time selection	0 to 3	0	☆
354.	E1.22	2 stage running time T2	0.0s(h) to 6500.0s(h)	0.0s(h)	☆
355.	E1.23	2 stage ac/deceleration time selection	0 to 3	0	☆
356.	E1.24	3 stage running time T3	0.0s(h) to 6500.0s(h)	0.0s(h)	☆
357.	E1.25	3 stage ac/deceleration time selection	0 to 3	0	☆
358.	E1.26	4 stage running time T4	0.0s(h) to 6500.0s(h)	0.0s(h)	☆
359.	E1.27	4 stage ac/deceleration time selection	0 to 3	0	☆
360.	E1.28	5 stage running time T5	0.0s(h) to 6500.0s(h)	0.0s(h)	☆
361.	E1.29	5 stage ac/deceleration time selection	0 to 3	0	☆
362.	E1.30	6 stage running time T6	0.0s(h) to 6500.0s(h)	0.0s(h)	☆
363.	E1.31	6 stage ac/deceleration time selection	0 to 3	0	☆
364.	E1.32	7 stage running time T7	0.0s(h) to 6500.0s(h)	0.0s(h)	☆
365.	E1.33	7 stage ac/deceleration time selection	0 to 3	0	☆
366.	E1.34	8 stage running time T8	0.0s(h) to 6500.0s(h)	0.0s(h)	☆
367.	E1.35	8 stage ac/deceleration time selection	0 to 3	0	☆
368.	E1.36	9 stage running time T9	0.0s(h) to 6500.0s(h)	0.0s(h)	☆
369.	E1.37	9 stage ac/deceleration time selection	0 to 3	0	☆
370.	E1.38	10 stage running time T10	0.0s(h) to 6500.0s(h)	0.0s(h)	☆
371.	E1.39	10 stage ac/deceleration time selection	0 to 3	0	☆
372.	E1.40	11 stage running time T11	0.0s(h) to 6500.0s(h)	0.0s(h)	☆
373.	E1.41	11 stage ac/deceleration time selection	0 to 3	0	☆
374.	E1.42	12 stage running time T12	0.0s(h) to 6500.0s(h)	0.0s(h)	☆

Chapter 5 Function parameter

375.	E1.43	12 stage ac/deceleration time selection	0 to 3	0	☆
376.	E1.44	13 stage running time T13	0.0s(h) to 6500.0s(h)	0.0s(h)	☆
377.	E1.45	13 stage ac/deceleration time selection	0 to 3	0	☆
378.	E1.46	14 stage running time T14	0.0s(h) to 6500.0s(h)	0.0s(h)	☆
379.	E1.47	14 stage ac/deceleration time selection	0 to 3	0	☆
380.	E1.48	15 stage running time T15	0.0s(h) to 6500.0s(h)	0.0s(h)	☆
381.	E1.49	15 stage ac/deceleration time selection	0 to 3	0	☆
382.	E1.50	Simple PLC run-time unit	0: S (seconds) 1: H (hours)	0	☆
383.	E1.51	Multi-stage command 0 reference manner	0: Function code E1.00 reference 1: Analog AI1 reference 2: Analog AI2 reference 3: Panel potentiometer setting 4: High-speed pulse setting 5: PID control setting 6: Keyboard set frequency (F0.01) setting, UP/DOWN can be modified 7. Analog AI3 given	0	☆

5-1-17. E2 Group - PID function

No.	Code	Parameter name	Setting range	Factory setting	Change
384.	E2.00	PID setting source	0: E2.01 setting 1: Analog AI1 reference 2: Analog AI2 reference 3: Panel potentiometer setting 4: High-speed pulse setting 5: Communications reference 6: Multi-stage command reference	0	☆
385.	E2.01	PID keyboard reference	0.0% to 100.0%	50.0%	☆
386.	E2.02	PID feedback source	0 to 8	0	☆
387.	E2.03	PID action direction	0: positive 1: negative	0	☆
388.	E2.04	PID setting feedback range	0 to 65535	1000	☆
389.	E2.05	PID inversion cutoff frequency	0.00 to F0.19(maximum frequency)	0.00Hz	☆
390.	E2.06	PID deviation limit	0.0% to 100.0%	0%	☆

391.	E2.07	PID differential limiting	0.00% to 100.00%	0.10%	☆
392.	E2.08	PID reference change time	0.00s to 650.00s	0.00s	☆
393.	E2.09	PID feedback filter time	0.00s to 60.00s	0.00s	☆
394.	E2.10	PID output filter time	0.00s to 60.00s	0.00s	☆
395.	E2.11	PID feedback loss detection value	0.0%: not judged feedback loss 0.1% to 100.0%	0.0%	☆
396.	E2.12	PID feedback loss detection time	0.0s to 20.0s	0.0s	☆
397.	E2.13	Proportional gain KP1	0.0 to 200.0	80.0	☆
398.	E2.14	Integration time Ti1	0.01s to 10.00s	0.50s	☆
399.	E2.15	Differential time Td1	0.00s to 10.000s	0.000s	☆
400.	E2.16	Proportional gain KP2	0.0 to 200.0	20.0	☆
401.	E2.17	Integration time Ti2	0.01s to 10.00s	2.00s	☆
402.	E2.18	Differential time Td2	0.00 to 10.000	0.000s	☆
403.	E2.19	PID parameter switching conditions	0: no switching 1: switching via terminals 2: automatically switching according to deviation.	0	☆
404.	E2.20	PID parameter switching deviation 1	0.0% to E2.21	20.0%	☆
405.	E2.21	PID parameter switching deviation 2	E2.20 to 100.0%	80.0%	☆
406.	E2.22	PID integral properties	Units digit: integral separation 0: Invalid; 1: Valid Tens digit: whether stop integration when output reaches limit 0: continue; 1: stop	00	☆
407.	E2.23	PID initial value	0.0% to 100.0%	0.0%	☆
408.	E2.24	PID initial value hold time	0.00s to 360.00s	0.00s	☆
409.	E2.25	Maximum deviation of twice outputs(forward)	0.00% to 100.00%	1.00%	☆
410.	E2.26	Maximum deviation of twice outputs(backward)	0.00% to 100.00%	1.00%	☆
411.	E2.27	Computing status after PID stop	0: stop without computing 1: stop with computing	1	☆
412.	E2.28	reserved			

Chapter 5 Function parameter

413.	E2.29	PID automatic decrease frequency selection	0: invalid; 1: valid	0	☆
414.	E2.30	PID stop frequency	0.00Hz~maximum frequency(F0.19)	25	☆
415.	E2.31	PID checking time	0s~3600s	10	☆
416.	E2.32	PID checking times	10~500	20	☆

5-1-18. E3 Group – Virtual DI、Virtual DO

No.	Code	Parameter name	Setting range	Factory setting	Change
417.	E3.00	Virtual VDI1 terminal function selection	0 to 50	0	★
418.	E3.01	Virtual VDI2 terminal function selection	0 to 50	0	★
419.	E3.02	Virtual VDI3 terminal function selection	0 to 50	0	★
420.	E3.03	Virtual VDI4 terminal function selection	0 to 50	0	★
421.	E3.04	Virtual VDI5 terminal function selection	0 to 50	0	★
422.	E3.05	Virtual VDI terminal status set	Units digit:Virtual VDI1 Tens digit:Virtual VDI2 Hundreds digit:Virtual VDI3 Thousands digit:Virtual VDI4 Tens of thousands:Virtual VDI5	00000	★
423.	E3.06	Virtual VDI terminal effective status set mode	Units digit:Virtual VDI1 Tens digit:Virtual VDI2 Hundreds digit:Virtual VDI3 Thousands digit:Virtual VDI4 Tens of thousands:Virtual VDI5	11111	★
424.	E3.07	A11 terminal as a function selection of DI	0 to 50	0	★
425.	E3.08	A12 terminal as a function selection of DI	0 to 50	0	★
426.	E3.09	Panel potentiometer as a function selection of DI	0 to 50		

427.	E3.10	AI as DI effective mode selection	Units digit: AI1 0:High level effectively 1:Low level effectively Tens digit:AI2(0 to 1,same as units digit) Hundreds digit: Panel potentiometer(0 to 1,same as units digit)	000	★
428.	E3.11	Virtual VDO1 output function selection	0 to 40	0	☆
429.	E3.12	Virtual VDO2 output function	0 to 40	0	☆
430.	E3.13	Virtual VDO3 output function	0 to 40	0	☆
431.	E3.14	Virtual VDO4 output function	0 to 40	0	☆
432.	E3.15	Virtual VDO5 output function	0 to 40	0	☆
433.	E3.16	VDO output terminal effective status selection	Units digit:VDO1 0:Positive logic 1:Negative logic Tens digit: VDO2(0 to 1,same as above) Hundreds digit:VDO3(0 to 1,same as above) Thousands digit:VDO4(0 to 1,same as above) Tens of thousands digit:VDO5 (0 to 1,same as above)	00000	☆
434.	E3.17	VDO1 output delay time	0.0s to 3600.0s	0.0s	☆
435.	E3.18	VDO2 output delay time	0.0s to 3600.0s	0.0s	☆
436.	E3.19	VDO3 output delay time	0.0s to 3600.0s	0.0s	☆
437.	E3.20	VDO4 output delay time	0.0s to 3600.0s	0.0s	☆
438.	E3.21	VDO5 output delay time	0.0s to 3600.0s	0.0s	☆

5-1-19. b0 Group -Motor parameters

No.	Code	Parameter name	Setting range	Factory setting	Change
439.	b0.00	Motor type selection	0: general asynchronous motor 1: asynchronous inverter motor 2: permanent magnet synchronous motor	0	★
440.	b0.01	Rated power	0.1kW to 1000.0kW	Depends on models	★
441.	b0.02	Rated voltage	1V to 2000V	Depends on models	★

Chapter 5 Function parameter

442.	b0.03	Rated current	0.01A to 655.35A (inverter power \leq 55kW) 0.1A to 6553.5A (inverter rate > 55kW)	Depends on models	★
443.	b0.04	Rated frequency	0.01Hz to F0.19 (maximum frequency)	Depends on models	★
444.	b0.05	Rated speed	1rpm to 36000rpm	Depends on models	★
445.	b0.06	Asynchronous motor stator resistance	0.001 Ω to 65.535 Ω (inverter power \leq 55kW) 0.0001 Ω to 6.5535 Ω (inverter power > 55kW)	Motor parameters	★
446.	b0.07	Asynchronous motor rotor resistance	0.001 Ω to 65.535 Ω (inverter power \leq 55kW) 0.0001 Ω to 6.5535 Ω (inverter power > 55kW)	Motor parameters	★
447.	b0.08	Asynchronous motor leakage inductance	0.01mH to 655.35mH (inverter power \leq 55kW) 0.001mH to 65.535mH (inverter power > 55kW)	Motor parameters	★
448.	b0.09	Asynchronous motor mutUal inductance	0.1mH to 6553.5mH (inverter power \leq 55kW) 0.01mH to 655.35mH (inverter power > 55kW)	Motor parameters	★
449.	b0.10	Asynchronous motor no-load current	0.01A to b0.03 (inverter power \leq 55kW) 0.1A to b0.03 (inverter power > 55kW)	Motor parameters	★
450.	b0.11	Synchronous motor stator resistance	0.001 Ω to 65.535 Ω (inverter power \leq 55kW) 0.0001 Ω to 6.5535 Ω (inverter power > 55kW)	-	★
451.	b0.12	Synchronous D-axis inductance	0.01mH to 655.35mH (inverter power \leq 55kW) 0.001mH to 65.535mH (inverter power > 55kW)	-	★
452.	b0.13	Synchronous Q-axis inductance	0.01mH to 655.35mH (inverter power \leq 55kW) 0.001mH to 65.535mH (inverter power > 55kW)	-	★
453.	b0.14	Synchronous motor back-EMF	0.1V to 6553.5V	-	★
454.	b0.15 to b0.26	Reserve			

455.	b0.27	Motor parameter auto tuning	0: no operation 1: asynchronous motor parameters still auto tuning 2: asynchronous motor parameters comprehensive auto tuning 11: synchronous motor parameters still auto tuning 12: synchronous motor parameters comprehensive auto tuning	0	★
456.	b0.28	Encoder type	0: ABZ incremental encoder 1: UVW incremental encoder 2: Rotational transformer 3: Sine and cosine encoder 4: Wire-saving UVW encoder	0	★
457.	b0.29	Encoder every turn pulse number	1 to 65535	2500	★
458.	b0.30	Encoder installation angle	0.00 to 359.90	0.00	★
459.	b0.31	ABZ incremental encoder AB phase sequence	0: forward 1: reverse	0	★
460.	b0.32	UVW encoder offset angle	0.00 to 359.90	0.0	★
461.	b0.33	UVW encoder UVW phase sequence	0: forward 1: reverse	0	★
462.	b0.34	Speed feedback PG disconnection detection time	0.0s: OFF 0.1s to 10.0s	0.0s	★
463.	b0.35	Pole-pairs of rotary transformer	1 to 65535	1	★

5-1-20. y0 Group - Function code management

No.	Code	Parameter name	Setting range	Factory setting	Change
-----	------	----------------	---------------	-----------------	--------

464.	y0.00	Parameter initialization	0: no operation 1: restore default parameter values, not including motor parameters 2: clear history 3: restore default parameter values, including motor parameters 4: backup current user parameters 501: restore from backup user parameters 10: Clear keyboard storage area3 11: upload parameter to keyboard storage area 1 12: upload parameter to keyboard storage area 2 21: download the parameters from keyboard storage 1 area to the storage system 3 22: download the parameters from keyboard storage 2 area to the storage system 3	0	★
465.	y0.01	User password	0 to 65535	0	☆
466.	y0.02	Function parameter group display selection	Units digit: d group display selection 0: not displays 1: displays Tens digit: E group display selection(the same above) Hundreds digit:b group display selection(the same above) Thousands digit:y group display selection(the same above) Tens thousands digit:L group display selection(the same above)	11111	★
467.	y0.03	Personality parameter group display selection	Units digit:User's customization parameter display selection 0:not display 1:display Tens digit :User's change parameter display selection 0:not display 1:display	00	☆
468.	y0.04	Function code modification properties	0: modifiable 1: not modifiable	0	☆

5-1-21. y1 Group -Fault query

No.	Code	Parameter name	Setting range	Factory setting	Change
469.	y1.00	Type of the first fault	0: No fault 1: Inverter unit protection	-	●
470.	y1.01	Type of the second fault	2: Acceleration overcurrent	-	●

471.	y1.02	Type of the third(at last) fault	3: Deceleration overcurrent 4: Constant speed overcurrent 5: Acceleration overvoltage 6: Deceleration overvoltage 7: Constant speed overvoltage 8: Control power failure 9: Undervoltage 10: Inverter overload 11: Motor Overload 12: Input phase loss 13: Output phase loss 14: Module overheating 15: External fault 16: Communication abnormal 17: Contactor abnormal 18: Current detection abnormal 19: Motor self-learning abnormal 20: Encoder/PG card abnormal 21: Parameter read and write abnormal 22: Inverter hardware abnormal 23: Motor short to ground 24: Reserved 25: Reserved 26: Running time arrival 27: Custom fault 1 28: Custom fault 2 29: Power-on time arrival 30: Load drop 31: PID feedback loss when running 40: Fast current limiting timeout 41: Switch motor when running 42: Too large speed deviation 43: Motor overspeed 45: Motor over-temperature 51: Initial position error COF: communication failure	-	•
472.	y1.03	Frequency of the third(at last) fault	-	-	•
473.	y1.04	Current of the third(at last) fault	-	-	•
474.	y1.05	Bus voltage of the third(at last) fault	-	-	•
475.	y1.06	Input terminal status of the third(at last) fault	-	-	•
476.	y1.07	Output terminal status of the third(at last) fault	-	-	•

Chapter 5 Function parameter

477.	y1.08	Reserved	-		
478.	y1.09	Power-on time of the third(at last) fault		-	●
479.	y1.10	Running time of the third(at last) fault	-	-	●
480.	y1.11	Reserve	-		
481.	y1.12	Reserve			
482.	y1.13	Frequency of the second fault		-	●
483.	y1.14	Current of the second fault	-	-	●
484.	y1.15	Bus voltage of the second fault	-	-	●
485.	y1.16	Input terminal status of the second fault	-	-	●
486.	y1.17	Output terminal status of the second fault	-	-	●
487.	y1.18	Reserved	-		
488.	y1.19	Power-on time of the second fault		-	●
489.	y1.20	Running time of the second fault	-	-	●
490.	y1.21	Reserve	-		
491.	y1.22	Reserve			
492.	y1.23	Frequency of the first fault		-	●
493.	y1.24	Current of the first fault	-	-	●
494.	y1.25	Bus voltage of the first fault	-	-	●
495.	y1.26	Input terminal status of the first fault	-	-	●
496.	y1.27	Output terminal status of the first fault	-	-	●
497.	y1.28	Reserved	-		
498.	y1.29	Power-on time of the first fault		-	●
499.	y1.30	Running time of the first fault	-	-	●

5-2. Function parameter description

5-2-1. Basic monitoring parameters: d0.00-d0.41

D0 parameters group is used to monitor the inverter running status information. User can view those information through the panel to facilitate on-site commissioning, also read parameters group value via communication for host computer monitoring.

For the specific parameters function code, name and the smallest unit, check Table 5-2.

Function code	Name	Unit
d0.00	Running frequency (Hz)	0.01Hz

Actual output frequency								
d0.01	Set frequency (Hz)	0.01Hz						
Actual set frequency								
d0.02	Bus voltage (V)	0.1V						
Detected value for DC bus voltage								
d0.03	Output voltage (V)	1V						
Actual output voltage								
d0.04	Output current (A)	0.01A						
Effective value for Actual motor current								
d0.05	Output power (kW)	0.1kW						
Calculated value for motor output power								
d0.06	Output torque (%)	0.1%						
Motor output torque percentage								
d0.07	DI input status	-						
DI input status, this value is a hexadecimal digits. The table listed each input terminal status sequence for each bit:								
<table border="1" style="margin-left: auto; margin-right: auto;"> <thead> <tr> <th>0 to 10 bits</th> <th>Input terminal status</th> </tr> </thead> <tbody> <tr> <td>0</td> <td>Invalid</td> </tr> <tr> <td>1</td> <td>Valid</td> </tr> </tbody> </table>			0 to 10 bits	Input terminal status	0	Invalid	1	Valid
0 to 10 bits	Input terminal status							
0	Invalid							
1	Valid							
Diagram 5-1:DI11 the sequence of the input terminal								
d0.08	DO output status	-						
DO output status, this value is a hexadecimal digits. The table listed each output terminal status sequence for each bit:								
<table border="1" style="margin-left: auto; margin-right: auto;"> <thead> <tr> <th>0 to 10 bits</th> <th>Output terminal status</th> </tr> </thead> <tbody> <tr> <td>0</td> <td>Invalid</td> </tr> <tr> <td>1</td> <td>Valid</td> </tr> </tbody> </table>			0 to 10 bits	Output terminal status	0	Invalid	1	Valid
0 to 10 bits	Output terminal status							
0	Invalid							
1	Valid							
Diagram 5-2:DO the sequence of the Output terminal								
d0.09	A11 voltage (V)	0.01V						
A11 input voltage value								
d0.10	A12 voltage (V)	0.01V						
A12 input voltage value								
d0.11	Panel potentiometer voltage (V)	0.01V						
A13 input voltage value								
d0.12	Count value	-						
Actual pulse count value in counting function								
d0.13	Length value	-						
Actual length in fixed length function								

Chapter 5 Function parameter

d0.14	Actual speed	-
Motor Actual running speed display		
d0.15	PID setting	%
Reference value percentage under PID adjustment mode		
d0.16	PID feedback	%
Feedback value percentage under PID adjustment mode		
d0.17	PLC stage	-
Stage display when PID program is running		
d0.18	High-speed pulse input pulse frequency (Hz)	0.01kHz
High-speed pulse input frequency display, unit: 0.01KHz		
d0.19	Feedback speed(unit:0.1Hz)	0.1Hz
PG feedback speed, to an accuracy of 0.1hz		
d0.20	Remaining run time	0.1Min
Remaining run time display, it is for timing run control		
d0.21	Linear speed	1m/Min
Show the line speed of DI5 high speed pulse sampling, according to the actual sample pulse number per minute and E0.07, calculate the line speed value.		
d0.22	Current power-on time	1Min
Total time of current inverter power-on		
d0.23	Current run time	0.1Min
Total time of current inverter run		
d0.24	High-speed pulse input pulse frequency	1Hz
High-speed pulse input frequency display, unit: 1hz		
d0.25	Communication set value	0.01%
Frequency, torque or other command values set by communication port		
d0.26	Encoder feedback speed	0.01Hz
PG feedback speed, to an accuracy of 0.01hz		
d0.27	Master frequency setting display	0.01Hz
Frequency set by F0.03 master frequency setting source		
d0.28	Auxiliary frequency setting display	0.01Hz
Frequency set by F0.04 auxiliary frequency setting source		
d0.29	Command torque (%)	0.1%
Display the set target torque under torque control mode		
d0.30	Reserve	
Reserve		
d0.31	Synchro rotor position	0.0°
Current position angle of synchronous motor rotor		
d0.32	Resolver position	-
Rotor position when rotary transformer is used as a speed feedback		
d0.33	ABZ position	0
Displays AB phase pulse count of the current ABZ or UVW encoder		
d0.34	Z signal counter	
Displays Z phase pulse count of the current ABZ or UVW encoder		
d0.35	Inverter status	
Displays inverter running status information Data definition format is as follows:		
Bit0	0: stop; 1: forward; 2: reverse	
Bit1		
Bit2	0: constant; 1: acceleration; 2: deceleration	
Bit3		
Bit4	0: bus voltage normal; 1: undervoltage	
d0.36	Inverter type	-

1:G type: Suitable for constant torque load		
2:F type: Suitable for variable torque load (fans, pumps load)		
d0.37	AI1 voltage before correction	0.01V
d0.38	AI2 voltage before correction	0.01V
d0.39	Panel potentiometer voltage before correction	0.01V
d0.40	Reserve	
d0.41	motor temperature inspection function3	0℃
Motor temperature sensor signal, need connect to control board S1 S2 GND terminal,		

5-2-2. Basic function group: F0.00-F0.27

Code	Parameter name	Setting range	Factory setting	Change Limit	
F0.00	Motor control mode	Vector control without PG	0	2	★
		Vector control with PG	1		
		V/F control	2		
<p>0: Vector control without PG Refers to the open-loop vector control for high-performance control applications typically , only one inverter to drive a motor.</p> <p>1: Vector control with PG Refers to the closed-loop vector control, motor encoder client must be installed , the drive must be matching with the same type of PG encoder card . Suitable for high-precision speed control or torque control . An inverter can drive only one motor.</p> <p>2:V/F control Suitable for less precision control applications, such as fan and pump loads .Oneinverter can be used for several motors at the same time.</p> <p>Note:When vector control mode , the drive andmotor capacity can not be vary widely.The drive's power can be bigger than motor's power two degree or smaller than motor's power one degree.If not, it may result in not very good performancecontrol , or the drive system does not work normally .</p>					
F0.01	Keyboard set frequency	0.00Hz to F0.19(maximum frequency)	50.00Hz	★	
When "Digital Setting" or "Terminal UP/DOWN " is selected as frequency source, the parameter value is the initial value of the inverter frequency digital setting.					
F0.02	Frequency command resolution	0.1Hz	1	2	★
		0.01Hz	2		
<p>This parameter is used to determine the resolution of all related frequency parameters. When the frequency resolution is 0.1Hz, PI500 maximum output frequency can reach 3200Hz, when the frequency resolution is 0.01Hz , PI500 maximum output frequency is 320.00Hz.</p> <p>Note: when modifying the function parameters, the number of decimal places of all related frequency parameters will change displayed, the frequency value will change accordingly.</p>					
F0.03	Frequency source master setting	Keyboard set frequency (F0.01, UP/DOWN can be modified, power-down without memory)	0	1	★
		Keyboard set frequency (F0.01, UP/DOWN can be modified, power-down with memory)	1		
		Analog AI1 setting	2		
		Analog AI2 setting	3		
		Panel potentiometer setting	4		
		High-speed pulse setting	5		
		Multi-speed operation setting	6		
		Simple PLC program setting	7		
PID control setting	8				

		Remote communications setting	9		
		Keyboard set frequency (F0.01, UP/DOWN can be modified, power-down without memory)	10		
<p>Select inverter master reference frequency input channels. There are 10 master reference frequency channels in all:</p> <p>0: Keyboard set frequency (F0.01, UP/DOWN can be modified, power-down without memory)</p> <p>Initial value for the set frequency is F0.01 "preset frequency" value. The set frequency value of the inverter can be changed by using the ▲ key and ▼ key on the keyboard (or multi-function input terminals UP, DOWN).</p> <p>The Inverter powers down and then powers on again, the set frequency value will be recovered as F0.01 "digital preset frequency value".</p> <p>1: Keyboard set frequency (F0.01, UP/DOWN can be modified, power-down with memory)</p> <p>Initial value for the set frequency is F0.01 "preset frequency" value. The set frequency value of the inverter can be changed by using the ▲ key and ▼ key on the keyboard (or multi-function input terminals UP, DOWN).</p> <p>The Inverter powers down and then powers on again, the set frequency value is same as the frequency of the last power-down</p> <p>Please note that F0.09 is for "digital set frequency stop memory selection ", F0.09 is used to select SAVE or CLEAR frequency correction when the inverter stops Besides, F0.09 is not related to the power-down memory but shutdown.</p> <p>2: Analog AI1 setting</p> <p>3: Analog AI2 setting</p> <p>4: Panel potentiometer setting</p> <p>6: Multi-speed operation setting</p> <p>When multi-stage command operation mode is selected, the different input state combination of DI terminal correspond to the different set frequency value. PI500 can set up more than 4 multi-stage command terminals and 16 statuses, and any 16 "multi-stage commands "can be achieved correspondence through E1 group function code, the "multi-stage command" refers to the percent of F0.19 relative to maximum frequency.</p> <p>Under the mode, DI terminal function in F1 group parameters will be required to set as the multi-stage command.</p> <p>7: Simple PLC program setting</p> <p>Under the mode, the inverter operating frequency source can be switched between 1 to 16 any frequency commands, the user can set hold time and ac/deceleration time for 1 to 16 frequency command , the specific content refers to the related E1 group instructions.</p> <p>8: PID control setting</p> <p>Select process PID control output as the operating frequency. Generally it is used for closed-loop control, such as constant pressure closed-loop control, constant tension closed-loop control and other occasions.</p> <p>Select PID as the frequency source, you need to set E2 group "PID function" parameters.</p> <p>9:Remote communications setting</p> <p>PI500 supports Modbus communication. Communication card must be installed when using the function.</p> <p>10: Analog AI3 input, voltage input range -10v~+10v</p>					
F0.04	Frequency source	Keyboard set frequency (F0.01, UP/DOWN can be modified, power-down without memory)	0	0	★
		Keyboard set frequency (F0.01, UP/DOWN can be modified, power-down with memory)	1		
	auxiliary setting				
	Frequency source	Analog AI1 setting	2		
	auxiliary setting	Analog AI2 setting	3		
		Panel potentiometer setting	4		
		High-speed pulse setting	5		
	Multi-speed operation setting	6			

		Simple PLC program setting	7		
		PID control setting	8		
		Remote communications setting	9		
		Keyboard set frequency (F0.01, UP/DOWN can be modified, power-down without memory)	10		
<p>The instructions for use refers to F0.03.</p> <p>When the frequency source auxiliary setting is used as overlays reference (select frequency source as master+auxiliary , master to master+auxiliary or auxiliary to master+auxiliary), you need to pay attention to:</p> <p>1) When the frequency source auxiliary setting is set to digital reference, the preset frequency (F0.01) does not work, user can adjust frequency by using ▲, ▼ keys (or multi-function input terminals UP, DOWN) on the keyboard, adjust directly on the basis of master frequency source.</p> <p>2) When the frequency source auxiliary setting is set to analog input reference (AI1, AI2, panel potentiometer) or pulse input reference, the frequency source auxiliary setting range for the set 100% can be set by F0.05 and F0.06.</p> <p>3) When the frequency source is set to pulse input reference, it is similar to analog reference .</p> <p>Tip: Both master and auxiliary setting of frequency source can not be set in the same channel, ie F0.03 and F0.04 can not be set as the same value, otherwise easily lead to confusion.</p>					
F0.05	Reference object selection for frequency source auxiliary setting	Relative to maximum frequency	0	0	☆
		Relative to master frequency source A	1		
		Relative to master frequency source 2	2		
F0.06	Frequency source auxiliary setting range	0% to 150%			☆
<p>When the frequency source is set to "frequency overlay"(i.e. F0.07 is set to 1, 3 or 4), these two parameters are used to determine the range of adjustment of frequency source auxiliary setting.</p> <p>F0.05 is used to determine the object corresponding to frequency source auxiliary setting range, either the maximum frequency or the frequency source master setting. If the frequency source master setting 1 is selected, so the frequency source auxiliary setting range will be subject to the change of the frequency source master setting, it applies for when auxiliary setting range is less than master setting range; If the frequency source master setting 2 is selected, so the frequency source auxiliary setting range will be subject to the change of the frequency source master setting, it applies for when auxiliary setting range is more than master setting range;</p> <p>Recommendation: frequency source master setting (F0.03) shall adopt analog setting, frequency source auxiliary setting (F0.04) shall adopt digital setting.</p>					
F0.07	Frequency source superimposed selection	Units digit	Frequency source selection	00	☆
		Frequency source master setting	0		
		Arithmetic result of master and auxiliary(arithmetic relationship depends on tens digit)	1		
		switch between frequency source master setting and auxiliary setting	2		
		Switch between frequency source master setting and arithmetic result of master and auxiliary	3		
		Switch between frequency source auxiliary setting and arithmetic result of master and auxiliary	4		
		Tens digit	Arithmetic relationship of master and auxiliary for frequency source		
		Master+auxiliary	0		
		Master-auxiliary	1		
		Max(master, auxiliary)	2		
		Min (master, auxiliary)	3		
Master*auxiliary/ maximum frequency	4				

Frequency source reference is achieved by compounding frequency source master setting and frequency source auxiliary setting

Units digit: frequency source selection:

0: Frequency source master setting

Frequency source master setting is used as command frequency

1: Arithmetic result of master and auxiliary is used as command frequency, for the arithmetic relationship of master and auxiliary, please see the instructions of function code "tens digit".

2: Switch between frequency source master setting and auxiliary setting, when multi-function input terminal 18 (frequency switching) is invalid, the frequency source master setting is selected as command frequency. when multi-function input terminal 18 (frequency switching) is valid, frequency source auxiliary setting is selected as command frequency.

3: Switch between the frequency source master setting and the arithmetic result of master and auxiliary, when multi-function input terminal 18 (frequency switching) is invalid, the frequency source master setting is selected as command frequency. When multi-function input terminal 18 (frequency switching) is valid, the arithmetic result of master and auxiliary is selected as command frequency.

4: Switch between the frequency source auxiliary setting and the arithmetic result of master and auxiliary, when multi-function input terminal 18 (frequency switching) is invalid, the frequency source auxiliary setting is selected as command frequency. When multi-function input terminal 18 (frequency switching) is valid, the arithmetic result of master and auxiliary is selected as command frequency.

Tens digit: arithmetic relationship of master and auxiliary for frequency source

0: frequency source master setting + frequency source auxiliary setting

The sum of frequency source master setting plus frequency source auxiliary setting is used as command frequency Achieve frequency overlay reference function.

1: frequency source master setting - frequency source auxiliary setting

The difference of frequency source master setting minus frequency source auxiliary setting is used as command frequency

2: MAX (master and auxiliary) take the largest absolute value in frequency source master setting and frequency source auxiliary setting as command frequency.

3: MIN (master and auxiliary) take the smallest absolute value in frequency source master setting and frequency source auxiliary setting as command frequency. In addition, when the arithmetic result of master and auxiliary is selected as frequency source, you can set offset frequency by F0.08 and overlay offset frequency to the arithmetic result of master and auxiliary, so as to respond flexibly to various needs.

4: frequency source master setting X frequency source auxiliary setting and divided by the maximum value of frequency as the frequency command.

F0.08	Frequency source offset frequency when superimposing	0.00Hz to F0.19(maximum frequency)	0.00Hz	☆
-------	--	------------------------------------	--------	---

The function code is only valid when the arithmetic result of master and auxiliary is selected as frequency source.

When the arithmetic result of master and auxiliary is selected as frequency source, F0.08 is used as offset frequency, and it overlays with the arithmetic result of master and auxiliary as the set value of final frequency so that the frequency setting can be more flexible.

F0.09	Shutdown memory selection for digital set frequency	W/O memory	0	1	☆
		With memory	1		

This feature is only frequency source for the digital set.

"W/O memory" refers to that the digital set frequency value will recovered to F0.01 (preset frequency) value when the inverter stops, and the frequency correction by the ▲/▼ key on the keyboard or terminals UP, DOWN is cleared.

"W/ memory" refers to that the digital set frequency is reserved when the inverter stops, and the frequency correction by the ▲/▼ key on the keyboard or terminals UP, DOWN remains valid.

F0.10	Frequency command UP / DOWN reference when running	Running frequency	0	0	★
		Set frequency	1		

<p>This parameter is valid only when the frequency source is the digital set value. when determining the keyboard ▲ ▼ keys or terminal UP/DOWN action, the method to correct the set frequency that is, the target frequency decreases or increases on the basis of the operating frequency or the set frequency. The obvious difference between two settings appears when the inverter is in the process of ac/deceleration, that is, if the inverter operating frequency is not same as the set frequency, the different choices of the parameters has very different effect.</p>					
F0.11	Command source selection	Keyboard control (LED off)	0	0 ☆	
		Terminal block control (LED on)	1		
		Communications command control (LED flashes)	2		
		Keyboard control+ Communications command control	3		
		Keyboard control+ Communications command control+ Terminal block control	4		
<p>Select inverter control command input channel. Inverter control commands include: start, stop, forward, reverse and jog, etc. 0: keyboard control ("LOCAL / REMOTE" lights out); Operate command control by using RUN, STOP/RESET Keys on the operation panel. 1: terminal block control ("LOCAL / REMOTE" lights up); Operate command control by using multi-function input terminals FWD, REV or FJOG. 2: communication command control("LOCAL / REMOTE" flashes) Gives the run command from the host computer through the means of communication. Select this option, the optional communication card(Modbus card) is required . 3.keyboard+communication command control Operation panel and communication command control. 4.keyboard+terminal block+communication command control Operation panel、 terminal block and communication command control.</p>					
F0.12	Binding frequency source for command source	Units digit	Keyboard command binding frequency source selection		000 ☆
		Not binded	0		
		Keyboard set frequency	1		
		A11	2		
		A12	3		
		Panel potentiometer	4		
		High-speed pulse setting	5		
		Multi-speed	6		
		Simple PLC	7		
		PID	8		
		Communications reference	9		
		Tens digit	Terminal block command binding frequency source selection (0 to 9, same as units digit)		
Hundreds digit	Communication command binding frequency source selection (0 to 9, same as units digit)				
<p>Define the combination of 3 operation command channels and 9 frequency reference channels for easily synchronously switching. The principle for above frequency source reference channel is same as frequency source master setting selection F0.03, please see the description of F0.03 function code. The different running command channel can be bundled with the same frequency reference channel. When command source has the available frequency source for bundling, in the valid period of command source , the set frequency source by F0.03 to F0.07 is no longer valid.</p>					
F0.13	Acceleration time 1	0.0s~6500s	-	☆	
F0.14	Deceleration time 1	0.0s~6500s	-	☆	

<p>Acceleration time refers to the required time when the inverter accelerates from zero frequency to F0.16.</p> <p>Deceleration time refers to the required time when the inverter decelerates from F0.16 to zero frequency.</p> <p>PI500 provides four groups of ac/deceleration time, user can select by using the digital input terminal DI, as follows:</p> <p>The first group: F0.13, F0.14; The third group: F7.10, F7.11; The second group: F7.08, F7.09; The fourth group: F7.12, F7.13.</p>																			
F0.15	Ac/Deceleration time unit	1 second 0.1 second 0.01 second	0 1 2	1	★														
<p>To meet the demand of the various on-site, PI500 provides three kinds of time unit: 1 second, 0.1 second and 0.01 second respectively.</p> <p>Note: when modifying the function parameters, the number of decimal places that the four groups of ac/deceleration time displayed will change displayed, the ac/deceleration time will change accordingly.</p>																			
F0.16	Ac/deceleration time reference frequency	Maximum frequency(F0.19) Set frequency 100Hz	0 1 2	0	★														
<p>Ac/deceleration time refers to the required time from zero frequency to F0.16 or from F0.16 to zero frequency.</p> <p>When F0.16 selects 1, the ac/deceleration time depends on the set frequency, if the set frequency change frequently, and the acceleration of the motor is varied, please use with caution.</p>																			
F0.17	Carrier frequency adjustment as per temperature	NO YES	0 1	0	☆														
<p>The adjustment of carrier frequency refers to that the inverter automatically adjusts the carrier frequency according to the radiator temperature, so as to reduce the carrier frequency .when the radiator temperature rises, and to restore the carrier frequency when the radiator temperature reduces.</p>																			
F0.18	Carrier Frequency	0.5kHz to 16.0kHz	-		☆														
<p>This function is mainly used for improving the noise and vibration phenomena that the inverter operation may occur If the carrier frequency is higher, there are more ideal current waveform and less motor noise. It is very applicable in the place to be muted. But at this time, the switching loss of main components is large, the whole unit fevers, the efficiency decreases and the output reduces. At the same time, there is a bigger radio interference, another problem is that the capacitive leakage current increases when running at the high carrier frequency, the equipped leakage protective device may cause malfunction or overcurrent.</p> <p>When running at the low carrier frequency, the above-mentioned phenomenon are opposite.</p> <p>There are different responds to carrier frequency for the different motors. The best carrier frequency can be obtained based on the Actual situation adjustment. However, with the increase of motor capacity, the smaller carrier frequency should be selected. This company reserves the right to limit the maximum carrier frequency.</p> <p>The adjustment of carrier frequency will have impacts on the following performances:</p> <table border="1" style="width: 100%; border-collapse: collapse;"> <tr> <td style="width: 50%;">Carrier Frequency</td> <td>Low → high</td> </tr> <tr> <td>Motor noise</td> <td>Large → small</td> </tr> <tr> <td>Output current waveform</td> <td>Poor → good</td> </tr> <tr> <td>Motor temperature</td> <td>High → low</td> </tr> <tr> <td>Inverter temperature</td> <td>Low → high</td> </tr> <tr> <td>Leakage current</td> <td>Small → large</td> </tr> <tr> <td>External radiation and interference</td> <td>Small → large</td> </tr> </table> <p>Note: the larger the carrier frequency, the higher the whole unit temperature</p>						Carrier Frequency	Low → high	Motor noise	Large → small	Output current waveform	Poor → good	Motor temperature	High → low	Inverter temperature	Low → high	Leakage current	Small → large	External radiation and interference	Small → large
Carrier Frequency	Low → high																		
Motor noise	Large → small																		
Output current waveform	Poor → good																		
Motor temperature	High → low																		
Inverter temperature	Low → high																		
Leakage current	Small → large																		
External radiation and interference	Small → large																		

F0.19	aximum output frequency	50.00Hz~320.00Hz	50.00Hz	★	
<p>If analog input, pulse input (DI5) or multi-stage command in PI500 is selected as frequency source, the respective 100.0% is calibrated relative to the parameter.</p> <p>When PI500 maximum output frequency reaches up to 3200Hz, in order to take into account the two indexes of frequency command resolution and frequency input range, the number of decimal places for frequency command can be selected by F0.02 .</p> <p>When F0.02 selects 1, the frequency resolution is 0.1Hz, at this time F0.19 can be set in the range from 50.0Hz to 3200.0Hz; When F0.02 selects 2, the frequency resolution is 0.01Hz, at this time F0.19 can be set in the range from 50.00Hz to 320.00Hz.</p>					
F0.20	Upper limit frequency source Upper limit frequency source	F0.21 setting	0	0	★
		AI1	1		
		AI2	2		
		Panel potentiometer setting	3		
		High-speed pulse setting	4		
		Communications reference	5		
<p>Setting upper limit frequency. The upper limit frequency can be set from either digital setting (F0.21) or analog input channels. If the upper limit frequency is set from analog input, the set 100% of analog input is relative to F0.19.</p> <p>To avoid the "Runaway", the setting of upper limit frequency is required, when the inverter reaches up to the set upper limit frequency value, the inverter will remain operation at the upper limit frequency, no further increase.</p>					
F0.21	Upper limit frequency	F0.23 (lower limit frequency) to F0.19 (maximum frequency)	50.00Hz	☆	
F0.22	Upper limit frequency offset	0.00Hz to F0.19 (maximum frequency)	0.00Hz	☆	
<p>When the upper limit frequency is set from the analog or the high-speed pulse, F0.22 will be used as the offset of set value, the overlay of the offset frequency and F0.20 is used as the set value of the final upper limit frequency.</p>					
F0.23	Lower limit frequency	0.00Hz to F0.21 (lower limit frequency)	0.00Hz	☆	
<p>When the frequency command is lower than the lower limit frequency set by F0.23, the inverter can shut down, and then run at the lower limit frequency or the zero speed, the running mode can be set by F7.18.</p>					
F0.24	Running direction	Same direction	0	0	☆
		Opposite direction	1		
<p>By changing the parameters, the motor steering can be achieved without changing the motor wiring, which acts as the adjustment of any two lines(U, V, W) of the motor to achieve the conversion of the motor rotation direction.</p> <p>Tip: after the parameter is initialized, the motor running direction will be restored to its original status. When the system debugging is completed, please use with caution where the change of motor steering is strictly prohibited.</p>					
F0.25	Reserve				
F0.26	Reserve				
F0.27	Inverter type	G type (constant torque load type)	1	-	●
		F type (fans/pumps load type)	2		
<p>The parameters is only for user to view the factory model and can not be changed. 1: Suitable for constant torque load 2: Suitable for variable torque load (fans, pumps load)</p>					

5-2-3. Input terminal: F1.00-F1.46

PI500 series inverter comes standard with eight multifunctional digital input terminals (where DI5 can be used as high-speed pulse input terminal), three analog input terminals.

Code	Parameter name	Setting range	Factory	Chan
------	----------------	---------------	---------	------

Chapter 5 Function parameter

			setting	ge
F1.00	DI1 terminal function selection	0~51	1	★
F1.01	DI2 terminal function selection	0~51	2	
F1.02	DI3 terminal function selection	0~51	0	
F1.03	DI4 terminal function selection	0~51	9	
F1.04	DI5 terminal function selection	0~51	12	
F1.05	DI6 terminal function selection	0~51	13	
F1.06	DI7 terminal function selection	0~51	0	
F1.07	DI8 terminal function selection	0~51	0	
F1.08	Undefined			
F1.09	Undefined			

These parameters are used to set the digital multi-function input terminal, the optional functions are shown in the following table:

Set value	Function	Description
0	No function	The terminal for not use can be set to "no function" to prevent accidental operation.
1	Forward run (FWD)	External terminals are used to control the FWD/REV run mode of inverter.
2	Reverse run (REV)	
3	Three-wire operation control	This terminal is used to determine the inverter's three-wire control mode. For details, please refer to the instructions of function code F1.10 ("terminal command mode).
4	Forward JOG(FJOG)	FJOG means Forward JOG running, RJOG means Reverse JOG running. For Jog running frequency and Jog Ac/deceleration time, please refer to the description of the function code F7.00, F7.01, F7.02.
5	Reverse JOG(RJOG)	
6	Terminal UP	Modify frequency increment/decrement command when the frequency is referenced by external terminal. Adjust up/down the set frequency when the digital setting is selected as the frequency source.
7	Terminal DOWN	
8	Free stop	The inverter output is blocked, at the time, the parking process of motor is not controlled by the inverter. This way is same as the principle of free stop described in F3.07.
9	Fault reset (RESET)	The function make use of terminal for fault reset. It has same function with RESET key on the keyboard. This function can be used to realize remote fault reset.
10	Run pausing	The inverter slows down and stops, but all operating parameters are memorized. Such as PLC parameters, wobble frequency parameters, and PID parameters. This terminal signal disappears, the inverter reverts to the previous state of running before parking.
11	External fault normally open input	When the signal is sent to the inverter, the inverter reports fault Err.15, and performs troubleshooting according to fault protection action (for details, please refer to the function code F8.17).
12	Multi-speed terminal 1	The setting of 16 stage speed or 16 kinds of other command can be achieved through the 16 states of the four terminals. For details, see Table 1
13	Multi-speed terminal 2	
14	Multi-speed terminal 3	

15	Multi-speed terminal 4	
16	Ac/deceleration time selection terminal 1	The selection of 4 ac/deceleration times can be achieved through the 4 states of the two terminals. For details, see Table 2
17	Ac/deceleration time selection terminal 2	
18	Frequency source switching	Used to switch between different frequency sources. According to frequency source selection function code (F0.07) settings, the terminal is used to switch between two frequency sources.
19	UP/DOWN setting (terminal, keyboard)	When the frequency reference is the digital frequency, this terminal is used to clear the changed frequency value by terminal UP/DOWN or keyboard UP/DOWN, so that the reference frequency can recover to the set value of F0.01.
20	Run command switch terminal 1	When the command source is set to the terminal control (F0.11 = 1), the terminal can be used to switch between terminal control and keyboard control. When the command source is set to the communication control (F0.11 = 2), the terminal can be used to switch between communication control and keyboard control.
21	Ac/deceleration prohibited	Ensure the inverter is free from external signals affect (except for shutdown command), maintain current output frequency.
22	PID pause	PID is temporarily disabled, the inverter maintains current output frequency, no longer performs PID adjustment of frequency source.
23	PLC status reset	When PLC pauses and runs again, this terminal is used to reset the inverter to the initial state of simple PLC.
24	Wobblulate pause	When the inverter outputs at center frequency. Wobblulate will pause
25	Counter input	Input terminal of the count pulse
26	Counter reset	Clear counter status
27	Length count input	Input terminal of the length count.
28	Length reset	Clear length
29	Torque control prohibited	When the inverter torque control is prohibited, the inverter will enter speed control mode.
30	High-speed pulse input (only valid for DI5)	DI5 is used as pulse input terminal.
31	Reserve	Reserve
32	Immediately DC braking	If the terminal is active, the inverter switches directly to DC braking status
33	External fault normally closed input	When the signal of external fault normally closed input is inputted into the inverter, the inverter will report fault Err.15 and shutdown.
34	Frequency change enable	If the function is set to be valid, when the frequency changes, the inverter does not respond to frequency changes until the terminal state is invalid.
35	PID action direction as reverse	If the terminal is valid, PID action direction opposites to the direction set by E2.03
36	External parking terminal 1	Under keyboard control mode, the terminal can be used to stop the inverter, same as STOP key on the keyboard.

37	Control command switch terminal 2	Used to switch between terminal control and communication control. If the command source is selected as terminal control, the system will be switched to the communication control mode when the terminal is active; vice versa.
38	PID integral pause	When the terminal is active, the PID integral adjustment function is paused, but the proportion and differential adjustments of PID are still valid.
39	Switch between frequency source master setting and preset frequency	When the terminal is active, the frequency source A is replaced by the preset frequency (F0.01)
40	Switch between frequency source auxiliary setting and preset frequency	When the terminal is active, the frequency source B is replaced with the preset frequency (F0.01)
41	Reserve	
42	Reserve	
43	PID parameter switching	When DI terminal (E2.19 = 1) is used to switch PID parameters, if the terminal is invalid, PID parameters use E2.13 to E2.15; if the terminal is valid, PID parameters use E2.16 to E2.18
44	Custom fault 1	When custom fault 1 and custom fault 2 are active, the inverter respectively alarms fault Err.27 and fault Err.28, and deals with them according to the mode selected by the fault protection action F8.19.
45	Custom fault 2	
46	Speed control / torque control switching	Switch between speed control mode and torque control mode under vector control mode. If the terminal is invalid, the inverter will run at the mode defined by FA.00 (speed/torque control mode); if the terminal is valid, the inverter will be switched to another mode.
47	Emergency parking	If the terminal is valid, the inverter will park at the fastest speed, and the current maintains at the set upper limit during the parking process. This function is used to meet the requirements that the inverter needs to stop as soon as possible when the system is in a emergency state.
48	External parking terminal 2	In any control mode (keyboard control, terminal control, communication control), the terminal can be used to decelerate the inverter until stop, at the time the deceleration time is fixed for deceleration time 4.
49	Deceleration DC braking	If the terminal is valid, firstly the inverter decelerates to the initial frequency of stop DC braking, and then switches directly to DC braking status.
50	Clear current running time	If the terminal is valid, the inverter's current running time is cleared, the function needs to work with Timing run (F7.42) and current running time arrival(F7.45).
51	Jog order3(set F7.54)	Jog running order, direction set through F7.54

Table 1 Multi command functions description

Over 4 segments command terminal, can be combined into 16 states, each state corresponds to the 16 instruction set value. As shown in Table 1 below:

K4	K3	K2	K1	Command setting	Parameters
OFF	OFF	OFF	OFF	0-stage speed setting 0X	E1.00
OFF	OFF	OFF	ON	1-stage speed setting 1X	E1.01
OFF	OFF	ON	OFF	2-stage speed setting 2X	E1.02
OFF	OFF	ON	ON	3-stage speed setting 3X	E1.03

OFF	ON	OFF	OFF	4-stage speed setting 4X	E1.04
OFF	ON	OFF	ON	5-stage speed setting 5X	E1.05
OFF	ON	ON	OFF	6-stage speed setting 6X	E1.06
OFF	ON	ON	ON	7-stage speed setting 7X	E1.07
ON	OFF	OFF	OFF	8-stage speed setting 8X	E1.08
ON	OFF	OFF	ON	9-stage speed setting 9X	E1.09
ON	OFF	ON	OFF	10-stage speed setting 10X	E1.10
ON	OFF	ON	ON	11-stage speed setting 11X	E1.11
ON	ON	OFF	OFF	12-stage speed setting 12X	E1.12
ON	ON	OFF	ON	13-stage speed setting 13X	E1.13
ON	ON	ON	OFF	14-stage speed setting 14X	E1.14
ON	ON	ON	ON	15-stage speed setting 15X	E1.15

When multi-speed is selected as frequency source, the 100.0% of function code E1.00 to E1.15 corresponds to maximum frequency F0.19. Multi-stage command is used for the function of multi-speed, also for PID reference source to meet the need to switch between different reference values.

Table 2 - function description of ac/deceleration time selection terminal.

Terminal 2	Terminal 1	Ac/deceleration time selection	Parameters
OFF	OFF	Acceleration time 1	F0.13、F0.14
OFF	ON	Acceleration time 2	F7.08、F7.09
ON	OFF	Acceleration time 3	F7.10、F7.11
ON	ON	Acceleration time 4	F7.12、F7.13

F1.10	Terminal command mode	Two-wire type 1	0	0	★
		Two-wire type 2	1		
		Three-wire type 1	2		
		Three-wire type 2	3		

This parameter defines four different modes to control inverter operation through external terminals.0: Two-wire type 1

This mode is the most commonly used two-wire mode. The forward/reverse operation of motor is determined by terminal DIx, DIy.

The terminal function is set as follows:

Terminals	Set value	Description
DIx	1	Forward run (FWD)
DIy	2	Reverse run (REV)

Of which, DIx and DIy are the multi-function input terminals of DI1 to DI10, the level is active.

K1	K2	Run Command
0	0	Stop
0	1	Reverse
1	0	Forward
1	1	Stop

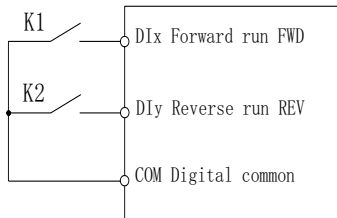

Diagram 5-3: Terminal command mode: Two wire mode 1

1: Two-wire type 2

In the mode, DIx terminal is used as running enabled, while DIy terminal is used to determine running direction.

The terminal function is set as follows:

Terminals	Set value	Description
-----------	-----------	-------------

DIx	1	Forward run (FWD)
DIy	2	Reverse run (REV)

Of which, DIx and DIy are the multi-function input terminals of DI1 to DI10, the level is active.

K1	K2	Run Command
0	0	Stop
0	1	Stop
1	0	Forward
1	1	Reverse

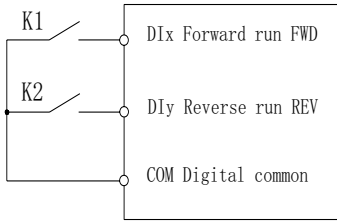

Diagram 5-4:Terminal command mode: Two wire mode 2

2: Three-wire control mode 1

In the mode, DI_n is used as enabled terminal, while DIx, DIy terminal are used to control direction. The terminal function is set as follows:

Terminals	Set value	Description
DIx	1	Forward run (FWD)
DIy	2	Reverse run (REV)
DI _n	3	Three-wire operation control

To run, firstly close DI_n terminal, the forward or reverse of motor is controlled by the ascendant edge of DIx or DIy pulse

To stop, you must disconnect DI_n terminal signals Of which, DIx, DIy and DI_n are the multi-function input terminals of DI1 to DI10, DIx and DIy are for active pulse, DI_n is for active level.

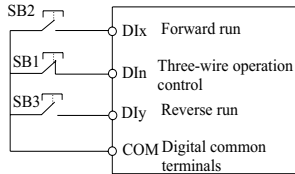

Diagram 5-5:Three-wire control mode 1

Of which:SB1: Stop button SB2: Forward button SB3: Reverse button

3: Three-wire control mode 2

In the mode, DI_n is the enabled terminal, the running commands are given by DIx, the direction is determined by the state of DIy.

The terminal function is set as follows:

Terminals	Set value	Description
DIx	1	Forward run (FWD)
DIy	2	Reverse run (REV)
DI _n	3	Three-wire operation control

To run, firstly close DI_n terminal, the motor run signal is generated by the ascendant edge of DIx, the motor direction signal is generated by DIy status

To stop, you must disconnect DI_n terminal signals Of which, DIx, DIy and DI_n are the multi-function input terminals of DI1 to DI10, DIx is for active pulse, DIy and DI_n are for active level.

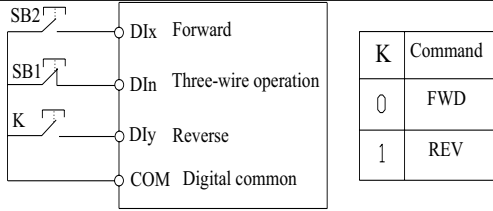

Diagram 5-6: Three-wire control mode 2

Of which: SB1: Stop button SB2: Run button

F1.11	Terminal UP / DOWN change rate	0.001Hz/s~65.535Hz/s	1.000Hz/s	☆
Used to set terminal UP/DOWN adjustment frequency, the rate of frequency change, i.e. frequency change amount per second. When F0.02 (frequency decimal point) is 2, the value range is 0.001Hz/s to 65.535Hz/s. When F0.22 (frequency decimal point) is 1, the value range is 0.01Hz/s to 655.35Hz/s.				
F1.12	Minimum input for AIC1	0.00V to F1.14	0.00V	☆
F1.13	F1.12 corresponding setting	-100.00% to 100.0%	0.0%	☆
F1.14	Maximum input for AIC1	F1.12 to 10.00V	10.00V	☆
F1.15	F1.14 corresponding setting	-100.00% to 100.0%	100.0%	☆

The above function codes are used to set the relationship between analog input voltage and its representatives set value.

When the analog input voltage is more than the set Maximum Input (F1.14), the analog voltage takes the Maximum Input as the calculated value, Similarly, when the analog input voltage is less than the set Minimum Input (F1.12), according to the Setting Selection For AI Less Than Minimum Input (F1.25), the analog voltage takes Minimal Input or 0.0% as the calculated value.

When the analog input is the current input, 1mA current is equivalent to 0.5V voltage.

All input filter time is used to set All software filter time, When the on-site analog quantity is easily interfered, please increase the filter time to stabilize the detected analog quantity, but the greater filter time, the slower analog detection response, the proper setting method depends on the actual application.

In the different applications, the 100.0% of analog setting vary from the meaning of its corresponding nominal value, please refer to the description of each application for details.

The three legends are for two typical settings.

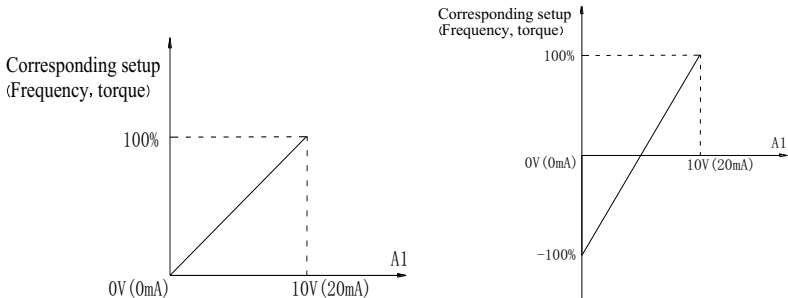

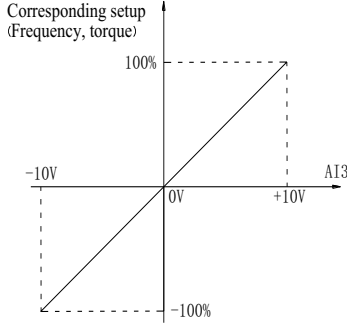

Diagram 5-7: Relationship between analog reference and set amount

F1.16	Minimum input for AIC2	0.00V~F1.18	0.00V	☆
F1.17	F1.16 Corresponding to the set	-100.00%~100.0%	0.0%	☆
F1.18	AIC2 max. input	F1.16~+10.00V	10.00V	☆
F1.19	F1.18 Corresponding to the set	-100.00%~100.0%	100.0%	☆
For the function and use of curve 2, please refer to the description of curve 1.				
F1.20	Minimum input for AIC3	0.00V~F1.22	0.00V	☆
F1.21	F1.20 Corresponding to the set	-100.00%~100.0%	0.0%	☆
F1.22	AIC3 Maximum input	F1.20~+10.00V	10.00V	☆
F1.23	F1.22 Corresponding to the set	-100.00%~100.0%	100.0%	☆

For the function and use of curve 3, please refer to the description of curve 1.

F1.24	AI curve selection	Units digit	All curve selection		321	☆
		Curve 1(2 points, refer to F1.12~F1.15)		1		
		Curve 2(2 points, refer to F1.16~F1.19)		2		
		Curve 3(2 points, refer to F1.20~F1.23)		3		
		Tens digit AI2 curve selection (1-3, the same as the units digit)				
Hundreds digit		Panel encoder curve selection (1-3, the same as the units digit)				

Units digit, tens digit and hundreds digit of the function code are used to respectively select the corresponding set curves of analog input AI1, AI2, Panel potentiometer
 3 analog input can respectively select any one of 3 curves.
 Curve 1, curve 2 and curve 3 are 2-point curve, they are set in F1 function code.

F1.25	AIinput setting selection	Units digit	AI1 Below the minimum input setting selection		000	☆
		Corresponding to the minimum input set		0		
		0.0%		1		
		Tens digit	Setting selection for AI2 less than minimum input(0 to 1, ditto)			
Hundreds digit	Setting selection for panel potentiometer less than minimum input(0 to 1, ditto)					

The function code is used to set analog quantity and its corresponding setting when the analog input voltage is less than the set Minimum Input.
 Units digit, tens digit and hundreds digit the function code respectively correspond to the analog input AI1, AI2, panel potentiometer. If 0 is selected, when the analog input is less than the Minimum Input, the setting corresponding to the analog amount is the setting of minimum input of the function code curve (F1.13, F1.17, F1.21).

If 1 is selected, when the analog input is less than the minimum input, the setting

corresponding to the analog amount is 0.0%.				
F1.26	HDI Minimum input	0.00kHz~F1.28	0.00kHz	☆
F1.27	F1.26 Corresponding to the set	-100.00%~100.0%	0.0%	☆
F1.28	HDI Maximun input	F1.26~100.00kHz	50.00kHz	☆
F1.29	F1.28 Corresponding to the set	-100.00%~100.0%	100.0%	☆
This group function code is used to set the relationship between DI5 pulse frequency and its corresponding setting.				
Pulse frequency can be inputted into the inverter only through DI5 channel. The application on this group of functions is similar to curve 1, please refer to the description of curve 1.				
F1.30	DI filter time	0.000s~1.000s	0.010s	☆
Set software filter time for DI terminals status. For the application that input terminals are vulnerable to interference and cause the accidental operation, you can increase this parameter so as to enhance the anti-interference ability. However, the increase of filter time will cause DI terminal slow response.				
F1.31	A11 filter time	0.00s~10.00s	0.10s	☆
F1.32	A12 filter time	0.00s~10.00s	0.10s	☆
F1.33	Panel encoder/AI3 filter time	0.00s~10.00s	0.10s	☆
F1.34	HDI filter time	0.00s~10.00s	0.00s	☆
F1.35	DI terminal Mode Selection 1	Units digit	D11 Terminal active state set	
		high level active		0
		Low level active		1
		Tens digit	D12 Terminal active state set (0~1,same as the units digit)	
		Hundreds digit	D13 Terminal active state set (0~1,same as the units digit)	
		Thousands digit	D14 Terminal active state set (0~1,same as the units digit)	
		Ten thousands digit	D15 Terminal active state set (0~1,same as the units digit)	
F1.36	DI terminal mode selection 2	Units digit	D16 Terminal active state set	
		high level active		0
		Low high level active		1
		Tens digit	D17 Terminal active state set (0~1,same as the units digit)	
		Hundreds digit	D18 Terminal active state set (0~1,same as the units digit)	
		Thousands digit	D19 Terminal active state set (0~1,same as the units digit)	
		Ten Thousands digit	D110 Terminal active state set (0~1,same as the units digit)	
For setting the digital input terminal of the active mode. When selecting high effective, appropriate DI terminal and COM communicated effectively, disconnect invalid. Select is low effective, appropriate DI terminal and COM connectivity invalid, disconnect effective.				
F1.37	D11 delay time	0.0s~3600.0s	0.0s	★
F1.38	D12 delay time	0.0s~3600.0s	0.0s	★
F1.39	D13 delay time	0.0s~3600.0s	0.0s	★
DI terminal for setting status changes, changes in the delay time of the inverter. Currently only D11, D12, D13 with delay time setting function.				
F1.40	Define the input terminal repeat	0: unrepeatable; 1: repeatable	0	★
0: unrepeatable Two different multi-function input terminals can not be set to the same				

function.
 I: repeatable You can repeat two different multi-function input terminal can be set to the same function.

F1.41	Keyboard potentiometer X1	0~100.00%	0.00%	☆
Keyboard potentiometer set value start point				
F1.42	Keyboard potentiometer X2	0~100.00%	100.00%	☆
Keyboard potentiometer set value end point				
F1.43	Keyboard potentiometer setting value	0~100.00%	-	☆

Display keyboard potentiometer value, through the keyboard potentiometer can modify Settings under monitoring menu.
 Keyboard potentiometer Settings can be used as frequency analogy, setting frequency = maximum frequency x keyboard potentiometer Settings.
 Eg.: Keyboard potentiometer Settings can be used as a PID given value, PID given value= Keyboard potentiometer Settings.

F1.44	Keyboard potentiometer X1 correspondent value is Y1	-100.00%~+100.00%	0.00%	☆
F1.45	Keyboard potentiometer X2 correspondent value is Y2	-100.00%~+100.00%	100.00%	☆

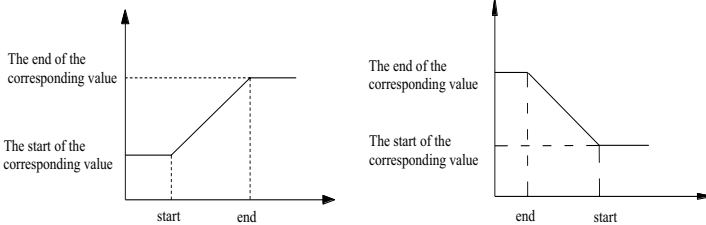

Diagram 5-8: Keyboard potentiometer X correspondent value is Y

F1.46	Keyboard potentiometer control	Units digit	Keyboard potentiometer power-down to save state	00	☆	
		Power-down save				0
		Power down zero clear				1
		Tensdigit	Keyboard potentiometer setting stop keep			0
		Stop keep				
		With stop command, zero clear				1
		Cleared at the end of down time				2
		Hundreds digit				Reserve
Thousands digit		Reserve				

5-2-4. Output terminal group: F2.00-F2.19

Code	Parameter name	Setting range	Factory setting	Change
F2.00	SPB terminal output selection	High speed pulse output	0	☆
		Switching output	1	
SPB terminals are programmable multiplex terminal can be used as high-speed pulse output terminal, it can also be used as open collector output terminal. As a high-speed pulse output, the maximum frequency of the output pulse is 100kHz, high-speed pulse output of the correlation function refer to Note F2.06.				
F2.01	Switching quantity output function selection (Open collector output terminal)	0~40	0	☆
F2.02	Relay 1 output function selection (TA1.TB1.TC1)	0~40	2	☆

F2.03	Undefined			
F2.04	SPA output function selection (collector open circuit output terminals)	0~40	1	☆
F2.05	Relay 2 output function selection (TA2.TB2.TC2)	0~40	1	☆
Above 5 function code is used to select five digital output function. Multifunctional output terminal functions are as follows:				
Setting value	Functions	Description		
0	No output	No output action		
1	Inverter running	Inverter is in running state, the output frequency (can be zero), the output ON signal.		
2	Fault output (fault down)	When the drive fails and downtime, the output ON signal.		
3	Frequency level detection FDT1 output	Please refer to the function code F7.23, F7.24's instructions.		
4	Frequency arrival	Please refer to the description of function code F7.25.		
5	Zero-speed running (no output when shutdown)	Inverter operation and the output frequency is 0, output ON signal. When the drive is shut down, the signal is OFF.		
6	Motor overload pre-alarm	Before the motor overload protection, according to the overload pre-alarm threshold value judgment, more than the pre-alarm threshold value output ON signal. Motor overload parameter settings refer to the function code F8.02 ~ F8.04.		
7	Inverter overload pre-alarm	Before the inverter overload occurs 10s, output ON signal. Setup counter arrive		
8	Setup counter arrive	When the count reaches the set value of E0.08, output ON signal. Specifies the count value reaches		
9	Specifies the count value reaches	When the count reaches the set value of E0.09, output ON signal. Counting Function Reference E0 group		
10	Length arrival	When the actual length of the detection of more than E0.05 set length, output ON signal.		
11	PLC cycle is complete	After simple PLC completes one cycle, the output of a pulse width of 250ms signal.		
12	Total running time arrival	Inverter total running time of more than F7.21 F6.07 set time, the output ON signal.		
13	Limited in frequency	When the set frequency exceeds the upper limit frequency or lower frequency, and output frequency is beyond the upper limit frequency or lower limit frequency, output ON signal.		
14	Torque limiting	Drive under the speed control mode, when the output torque reaches the torque limit, the inverter is stall protection status, while the output ON signal.		
15	Ready to run	When the inverter main circuit and control circuit power supply has stabilized, and the drive does not detect any fault information, the drive is in an operational state, output ON signal.		
16	AI1>AI2	When the value of the analog input AI is greater than the value of AI2 input and output ON signal.		
17	Upper frequency arrival	When the operating frequency reaches the upper frequency, output ON signal.		
18	The lower frequency arrival (no output when shutdown)	When the operating frequency reaches the lower frequency, output ON signal. The next stop status signal is OFF.		

19	Under voltage state output	When the inverter is in an undervoltage condition, output ON signal.		
20	Communication setting	Refer to the communication protocol.		
21	Reserve	Reserve		
22	Reserve	Reserve		
23	Zero-speed operation 2 (shutdown also output)	The inverter's output frequency is 0, output ON signal. The signal is also ON when shutdown.		
24	Cumulative power-on time arrival	When the inverter's accumulated power on time (F6.08) over F7.20 the set time, the output ON signal.		
25	Frequency level detection FDT2 output	Please refer to the function code F7.26, F7.27's instructions.		
26	Frequency 1 reaches output	Please refer to the function code F7.28, F7.29's instructions.		
27	Frequency 2 reaches output	Please refer to the function code F7.30, F7.31's instructions.		
28	Current 1 reaches output	Please refer to the function code F7.36, F7.37's instructions.		
29	Current 2 reaches output	Please refer to the function code F7.38, F7.39's instructions.		
30	Timing reach output	When the timer function selection (F7.42) is valid, the drive time to reach this run after the set time runs out, output ON signal.		
31	All input overrun	When the value of analog input All greater than F7.51 (All input protection limit) or less than F7.50 (All input protection under), output ON signal.		
32	Off load	When the inverter is off-load state, output ON signal.		
33	Reverse operation	Inverter in reverse run, output ON signal		
34	0 current state	Refer to the description of function code F7.32, F7.33.		
35	Module temperature reaches	Inverter module heatsink temperature (F6.06) reach the set module temperature reaches value (F7.40), output signal ON.		
36	Software current limit	Please refer to the function code F7.34, F7.35's instructions.		
37	The lower frequency arrival (stop and output)	When the operating frequency reaches the lower limit frequency, output ON signal. In shutdown state of the signal is also ON.		
38	Alarm output	When the inverter failure, and the failure of the process to continue to run mode, the inverter alarm output.		
39	Motor overtemperature pre-warning	When the motor temperature reaches F8.35 (motor overheat pre-alarm threshold), the output ON signal. (Motor temperature can be viewed at d0.41)		
40	Current running time of arrival	When the inverter starts running time is longer than the time set by F7.45, it outputs ON signal.		
F2.06	High-speed pulse output function selection	0~17	0	☆
F2.07	DA1 output function selection	0~17	0	☆
F2.08	DA2 output function selection	0~17	1	☆
High-speed pulse output frequency range of 0.01kHz ~ F2.09 (high speed pulse output maximum frequency), F2.09 can be set between 0.01kHz ~ 100.00kHz.				
Analog Output DA1 and DA2 output range is 0V ~ 10V, or 0mA ~ 20mA. Pulse output or				

analog output range, with the corresponding scaling function relationship in the following table:

Setting value	Functions	Description			
0	Running frequency	0~Max. output frequency			
1	Set frequency	0~ Max. output frequency			
2	Output current	0~2 times the motor rated current			
3	Output torque	0~2 times the motor rated toqure			
4	Output power	0~2 times rated power			
5	Output voltage	0~1.2 times inverter rated voltage			
6	High speed pulse input	0.01kHz~100.00kHz			
7	Anolog AI1	0V~10V (Or 0~20mA)			
8	Anolog AI2	0V~10V(or 0~20mA)			
9	Anolog AI3	0V~10V			
10	Lentgh value	0~Max. setting length			
11	The count value	0~Max. count value			
12	Coummunication set	0.0%~100.0%			
13	Motor speed	0~Max. output frequency correspondent speed			
14	Output current	0.0A~100.0A(Inverter power \leq 55kW); 0.0A~1000.0A(Inverter power>55kW)			
15	DC bus voltage	0.0V~1000.0V			
16	Reserve	Reserve			
17	Frequency source main set	0~Max. output frequency			
F2.09	Maximum frequency of high-speed pulse	0.01kHz~100.00kHz	50.00k	☆	
When the SPB terminal as a pulse output, the function code is used to select the maximum output pulse frequency value.					
F2.10	SPB output delay	0.0s~3600.0s	0.0s	☆	
F2.11	Relay 1 output delay time	0.0s~3600.0s	0.0s	☆	
F2.12	Expansion card DO output delay time	0.0s~3600.0s	0.0s	☆	
F2.13	SPA output delay time	0.0s~3600.0s	0.0s	☆	
F2.14	Relay 2 output delay time	0.0s~3600.0s	0.0s	☆	
Set the output terminal SPA, SPB, relay 1, relay 2, delay time of changing from the state produced to the actual output differentiated.					
F2.15	DO terminal active status selection	Units digit	SPB switching active status selection		00000 ☆
		Positive		0	
		Negtive		1	
		Tens digit	Relay 1 active setting (0 to 1, as defined in units digit)		
		Hundreds digit	Reserve		
		Thousands digit	SPA Terminal active state settings (0 to 1, as defined in units digit)		
Tens thousand digit	Relay 2 active setting (0 to 1, as defined in units digit)				
Define the output terminal SPA, SPB, relay 1, relay 2 output logic.					
0: positive, digital output terminal and the corresponding public terminal connectivity to the active state, disconnecting is inactive state;					
1: negative, digital output terminal and the corresponding public terminal connectivity to the inactive state, disconnecting is active state.					
F2.16	DA1 zero bias coefficient	-100.0%~+100.0%	0.0%	☆	

Chapter 5 Function parameter

F2.17	DA1 gain	-10.00~+10.00	1.00	☆
F2.18	DA2 zero bias coefficient	-100.0%~+100.0%	0.00%	☆
F2.19	DA2 gain	-10.00~+10.00	1.00	☆

The above function codes generally used to bias the output amplitude of zero drift and correcting the analog output. It can also be used to customize the desired analog output curve.

Calculation relationship with DA1 example:
y1 represents DA1 minimum output voltage or current value; y2 represents DA1 maximum output voltage or current value
 $y1=10V$ or $20mA * F2.16 * 100\%$;
 $y2=10V$ or $20mA * (F2.16 + F2.17)$;
Factory Default $F2.16 = 0.0\%$, $F2.17 = 1$, so the output $0 \sim 10V$ (or $0 \sim 20mA$) corresponding to characterize the physical minimum value to characterize the physical maximum.

Example 1:
 $0 \sim 20mA$ output will be changed to $4 \sim 20mA$
The minimum input current value from the formula: $y1 = 20mA * F2.16 * 100\%$,
 $4=20 * F2.16$, calculated according to the formula $F2.16=20\%$;
Maximum input current value by the formula: $y2=20mA * (F2.16 + F2.17)$;
 $20=20 * (20\% + F2.17)$, calculated according to the formula $F2.17=0.8$

Example 2:
 $0 \sim 10V$ output will be changed to $0 \sim 5V$
The minimum input voltage value from the formula: $y1=10 * F2.16 * 100\%$,
 $0=10 * F2.16$, calculated according to the formula $F2.16=0.0\%$;
The maximum input voltage value from the formula: $y2=10 * (F2.16 + F2.17)$;
 $5=10 * (0 + F2.17)$, calculated according to the formula $F2.17=0.5$

5-2-5. Start and stop control group: F3.00-F3.15

Code	Parameter name	Setting range	Factory setting	Change
F3.00	Start-up mode	Direct startup	0	☆
		Speed tracking restart	1	
		Pre-excitation start (AC asynchronous motor)	2	
<p>0: Directly startup If the start DC braking time is set to 0, the inverter starts running from the start frequency. If the start DC braking time is not set to 0, the inverter firstly performs DC braking and then starts running from the start frequency. Applicable for the small inertia load and the application that the motor may rotate when starting.</p> <p>1: Speed tracking restart The inverter firstly judges the speed and direction of motor, and then starts at the tracked motor frequency, smoothly starts the rotating motor without shocks. Applicable for the momentary power cut and restart with high inertia loads. To ensure the performance of Speed Tracking Restart, it is required to accurately set the parameters of motor b0 group.</p> <p>2: Asynchronous motor pre-excitation start It is valid only for asynchronous motors, used to firstly create magnetic field before the motor running. Please refer to the instructions of function code F3.05, F3.06 for pre-excitation current and pre-excitation time</p> <p>If the pre-excitation time is set to 0, the inverter will cancel the pre-excitation process, and starts from the start frequency. If the pre-excitation time is not set to 0, the inverter will firstly perform pre-excitation process and then starts so as to improve the dynamic response performance of motor.</p>				
F3.01	Speed tracking mode	0~2: Reserve Hard speed tracking mode	3	★

Hard speed tracking mode, automatically detect and track motor speed, no impact start to the rotating motor but smoothly.					
F3.02	Speed tracking speed	1~100	20	☆	
When speed tracking restart, select speed tracking of speed, parameter smaller, the track faster. But is too small may cause tracking result is not reliable.					
F3.03	Start frequency	0.00Hz~10.00Hz	0.00Hz	☆	
F3.04	Hold time for start frequency	0.0s~100.0s	0.0s	★	
<p>When the inverter starts, firstly run at the start frequency, the running time is the hold time for start frequency, afterwards run at the frequency reference.</p> <p>The start frequency F3.03 is not limited by the lower limit frequency. But if the set target frequency is less than the start frequency, the inverter does not start and keeps in the standby state.</p> <p>The hold time for start frequency is inactive when switching between forward rotation and reverse rotation. The hold time for start frequency is not included in the acceleration time, but the simple PLC run-time. Example 1:</p> <p>F0.03=0 the frequency source is set to digital reference F0.01=2.00Hz the digital set frequency is 2.00Hz F3.03=5.00Hz the start frequency is 5.00Hz F3.04=2.0s the hold time for start frequency is 2.0s, at this time, the inverter will be in the standby state with the output frequency of 0.00Hz.</p> <p>Example 2:</p> <p>F0.03=0 the frequency source is set to digital reference F0.01=10.00Hz the digital set frequency is 10.00Hz F3.03=5.00Hz the start frequency is 5.00Hz F3.04=2.0s the hold time for start frequency is 2.0s</p> <p>At this point, the inverter accelerates to 5.00Hz for 2.0s, and then accelerates to the reference frequency of 10.00Hz.</p>					
F3.05	DC Pre-excitation current	0%~100%	0%	★	
F3.06	DC Pre-excitation time	0.0s~100.0s	0.0s	★	
<p>DC brake, generally used to stop and start the motor running. Pre-excitation is used to enable the establishment of magnetic field induction motor and then start to improve the response speed.</p> <p>DC brake is valid only in start-up mode for the direct start. At this point the drive to start first by setting the DC braking current DC braking, DC braking time after the start and then start running. If the set DC braking time is 0, no start directly after DC braking. DC braking current increases, the greater the braking force.</p> <p>If the start-up mode for the asynchronous machine to start pre-excitation, the drive pre-press set excitation current pre-established field, after the set pre-magnetizing time before starting operation. If the set pre-magnetizing time is 0, no pre-excitation processes started directly. DC brake current / pre-excitation current, is the percentage of relative inverter rated current.</p>					
F3.07	Stop mode	Deceleration stop	0	0	☆
		Free stop	1		
F3.08	DC start frequency	0.00Hz~F0.19(maximum-frequency)	0.00Hz	☆	
F3.09	DC waiting time	0.0s~100.0s	0.0s	☆	
F3.10	Stop braking current	0%~100%	0%	☆	
F3.11	Stop braking time	0.0s~100.0s	0.0s	☆	
<p>DC Start Frequency: deceleration stop process, when the operating frequency to reduce the frequency to start DC braking process.</p> <p>DC waiting time: at the operating frequency is reduced to shutdown DC brake starting frequency, the inverter will stop output for some time, and then start DC braking process. At high speed to prevent the start of DC braking can cause the overcurrent fault.</p> <p>Stop braking current: DC braking means the output current, the percentage relative to motor nominal current. This value is larger the DC brake effect is stronger, but the greater the heat the</p>					

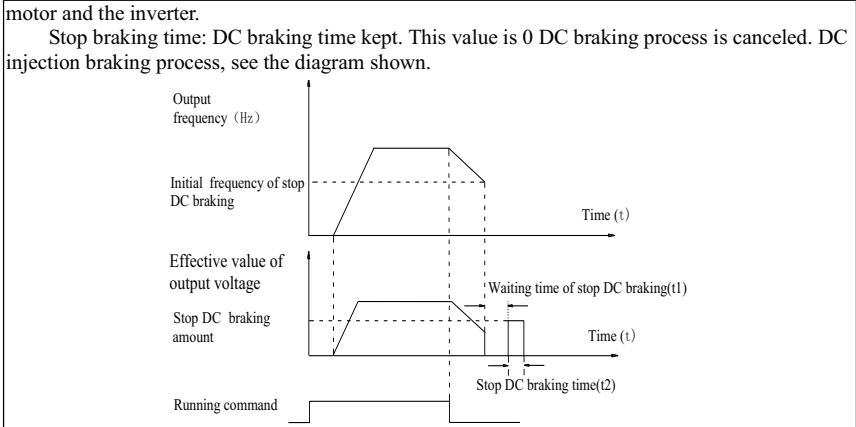

Diagram 5-9:Schematic diagram of stop DC braking time

F3.12	Braking utilization rate	0%~100%	100%	☆
F3.13	Ac/deceleration mode	Linear acceleration and deceleration	0	★
		S curve acceleration and deceleration A	1	
		S curve acceleration and deceleration B	2	

Select the frequency change mode in the process of start/stop.

0: Linear acceleration and deceleration
 The output frequency increases or decreases linearly. PI500 provides four kinds of acceleration and deceleration time. You can select by the multi-function digital input terminals (F1.00 to F1.08).

1: S curve acceleration and deceleration A
 The output frequency increases or decreases at the S curve. S-curve is used for the occasion that requires to gently start or stop, such as elevators, conveyor belts, etc..The function code F3.14 and F3.15 respectively defined the proportion of S curve start-section and the proportion of S curve end-section

2: S curve acceleration and deceleration B
 In the mode of S curve acceleration and deceleration B, the motor rated frequency fb is always the inflection point of S curve. Usually used for the occasion of high-speed regional above the rated frequency that requires rapid acceleration and deceleration.

When the frequency is higher than the rated frequency,the acceleration and deceleration are:

$$t = \left[\frac{4}{9} \times \left(\frac{f}{f_b} \right)^2 + \frac{4}{9} \right] \times T$$

And ,'f' means the setting frequency, 'fb'means the rated frequency .'T' means the time from 0 to rated frequency (fb).

F3.14	Proportion of S curve start-section	0.0%~(100.0%~F3.15)	30.0%	★
F3.15	Proportion of S curve end-section	0.0%~(100.0%~F3.14)	30.0%	★

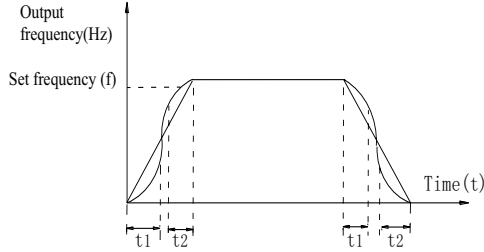

Diagram 5-10:Schematic diagram of S curve ac/deceleration A

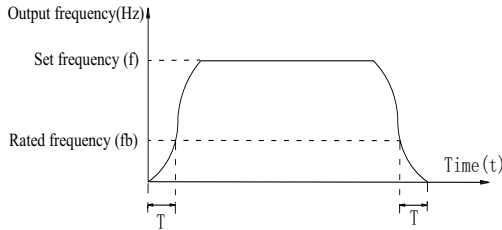

Diagram 5-11:Schematic diagram of S curve ac/deceleration B

The function code F3.14 and F3.15 respectively defined the proportion of start-section and the proportion of end-section for S curve acceleration and deceleration A, the two function code must meet: $F3.14 + F3.15 \leq 100.0\%$.

In the Figure of the S-curve acceleration and deceleration A, t_1 is the time parameter defined by F3.14, the slope of the output frequency variation during this period is gradually increasing. t_2 is the time parameter defined by F3.15, the slope of the output frequency variation during the period is gradually changed to 0. Within the time between t_1 and t_2 , the slope of the output frequency variation is fixed, i.e. the linear acceleration and deceleration is achieved in this interval.

5-2-6. V/F control parameters: F4.00-F4.14

This group of function code is only valid to V/F control, invalid to vector control.

V/F control is suitable for fans, pumps and other universal loads, or one inverter control multiple motors, or for the applications that inverter power is significantly different from the motor power.

Code	Parameter name	Setting range		Factory setting	Change Limit
F4.00	V/F curve setting	Linear V/F	0	0	★
		Multi-point V/F	1		
		Square V/F	2		
		1.2th power V/F	3		
		1.4th power V/F	4		
		1.6th power V/F	6		
		1.8th power V/F	8		
		Reserve	9		
		V/F completely separate	10		
		V/F half separate	11		

0: linear V/F,Suitable for ordinary constant torque load.

1: multi-point V/F,Suitable for dehydrator, centrifuge and other special loads any V/F relationship curves can be obtained by setting parameters F4.03 to F4.08.

2: square V/F,Suitable for fans, pumps and centrifugal loads.

3 to 8: V/F relationship curve between linear V/F and square V/F.

10:VF separate completely mode. In this mode, the output frequency and output voltage is separated completely, no any relationship at all, the output frequency controlled by frequency source setting , but output voltage determined by F4.12 setting.(V/F separate voltage supply source).V/F separated completely mode can suitable for in inductive heating, inverter power supply, torque motor, etc applications.

11: V/F semi-separate mode,V is proportional to F in this mode, but the proportional relationship can be set by F4.12 parameters, furthermore, the V and F proportion also relate to rated voltage of motor and rated frequency in b0 group.Assume that input voltage source is X (X value range from 0~100%), the output voltage V and output frequency F proportion relationship can be defined as : $V/F=2*X*(\text{rated voltage of motor}) / (\text{rated frequency of motor})$

F4.01	Torque boost	0.0%: automatic torque boost 0.1% to 30.0%	-	★
F4.02	Torque boost cut-off frequency	0.00Hz to F0.19 (maximum frequency)	15.00Hz	★

Torque boost is mainly used to improve the characteristics of the torque low-frequency under V/F control mode. If the torque boost is too low, the motor will work at the lower speed and power. If the torque boost is too high, the motor will run with overexcitation, the inverter's output current increases and the efficiency is reduced.

It is recommended to increase this parameter when the motor works with heavy load but without enough torque. The torque boost can be reduced when the load is lighter. When the torque boost is set to 0.0, the inverter will automatically perform torque boost, the inverter can automatically calculates the required torque boost value according to the motor stator resistance parameters.

Torque boost cutoff frequency: torque boost is valid below this frequency, invalid above the set frequency.

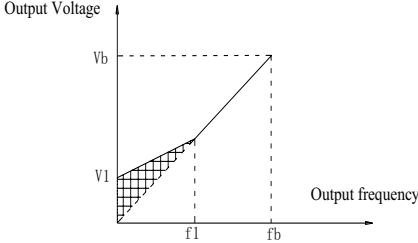

V1: Manual torque boost voltage Vb: Maximum output voltage
f1: Manual torque boost cut-off frequency fb: Rated operating frequency

Diagram 5-12:Schematic diagram of manual torque boost voltage

F4.03	Multi-point V/F frequency point F1	0.00Hz~F4.05	0.00Hz	★
F4.04	Multi-point V/F voltage point V1	0.0%~100.0%	0.0%	★
F4.05	Multi-point V/F frequency point F2	F4.03~F4.07	0.00Hz	★
F4.06	Multi-point V/F voltage point V2	0.0%~100.0%	0.0%	★
F4.07	Multi-point V/F frequency point F3	F4.05~b0.04(rated motor frequency)	0.00Hz	★
F4.08	Multi-point V/F voltage point V3	0.0%~100.0%	0.0%	★

F4.03 to F4.08 six parameters are used to define multi-point V/F curve.

The multi-point V/F curve is set according to the load characteristics of motor, please be noted that the relationship between three voltage points and three frequency points must be meet: $V1 < V2 < V3, F1 < F2 < F3$. The setting of multi-point V/F curve is as shown in below figure.

In the state of low frequency, if the voltage is set to a higher value, which may cause motor overheating even burnt, the inverter may appear overcurrent stall or overcurrent protection.

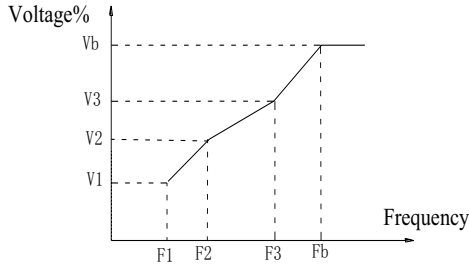

V1-V3: Voltage percentage of stage 1-3 to multi-speed V/F
 F1-F3: Frequency percentage of stage 1-3 to multi-speed V/F
 Vb: Rated motor voltage
 Fb: Rated motor operating frequency

Diagram 5-13: Schematic diagram of multi-point V/F curve setting

F4.09	V/F slip compensation gain	0%~200.0%	0.0%	☆
<p>This parameter is valid only for asynchronous motors. V/F slip compensation can compensate for the speed deviation of asynchronous motor when the load increases, so as to keep stable speed when the load changes. If V/F slip compensation gain is set to 100.0%, it means that the compensated deviation is equal to the rated motor slip under the rated motor load mode, while the rated motor slip can be calculated through b0 group of motor rated frequency and rated speed. When adjusting V/F slip compensation gain, generally it is based on the principle that the motor speed is the same as the target speed. When the motor speed is different from target value, it is necessary to appropriately fine-tune the gain.</p>				
F4.10	V/F overexcitation gain	0~200	64	☆
<p>In the process of the inverter's deceleration, the over-excitation control can suppress the rise of bus voltage to avoid overvoltage fault. The greater overexcitation gain, the stronger the inhibitory effect. For the occasions that the inverter's deceleration easily cause over pressure alarm, the overexcitation gain needs to be improved. But if overexcitation gain is too large, which easily lead to the increase of output current, you need to weigh in practical applications. For the small inertia occasions that the inverter's deceleration will not cause voltage rise, it is recommended to set overexcitation gain as 0; the set value is also suitable for the occasions with braking resistor.</p>				
F4.11	V/F oscillation suppression gain	0~100	0	☆
<p>The method of selecting gain is to take the value as smaller as possible with the premise that effectively suppressing oscillation, in order to avoid the adverse effect caused by V/F running. Please select 0 as the gain when the motor has no oscillation phenomenon. Only increase gain value when the motor has obvious oscillation, the greater gain, the more obvious the suppression of oscillation. When using the function of oscillation suppression, which requires that the motor's rated current and no-load current parameters must be accurate, otherwise V/F oscillation suppression is ineffective.</p>				
F4.12	V/F separation voltage source	Digital setting(F4.13)	0	☆
		A11	1	
		A12	2	
		Panel potentiometer	3	
		High-speed pulse setting(DI5)	4	
		Multistage instruction setting	5	
Simple PLC	6			

		PID	7	
		Communications given	8	
		Analog AI3 setting	9	
		100.0% Corresponding to the motor rated voltage(b0.02)		
F4.13	V/F separation voltage digital setting	0V to rated motor voltage	0V	☆
F4.14	V/F separation voltage rise time	0.0s to 1000.0s	0.0s	☆

5-2-7. Vector control parameters: F5.00-F5.15

F5 function code is only valid to vector control, invalid to V/F control

Code	Parameter name	Setting range	Factory setting	Change Limit
F5.00	Proportion of speed loop G1	1~100	30	☆
F5.01	Speed loop integral T1	0.01s~10.00s	0.50s	☆
F5.02	Switching frequency 1	0.00~F5.05	5.00Hz	☆
F5.03	Proportion of speed loop G2	1~100	20	☆
F5.04	Speed loop integral T2	0.01s~10.00s	1.00s	☆
F5.05	Switching frequency 2	F5.02~F0.19(max frequency)	10.00Hz	☆

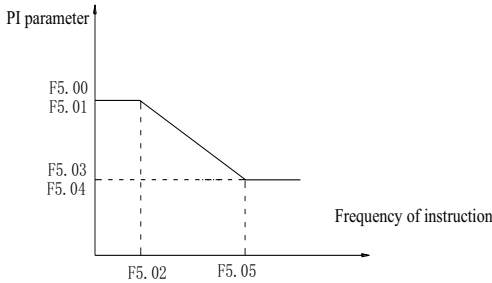

Diagram 5-14:PI parameter diagram

Converter operating in different frequency can choose different speed ring PI parameters. Operating frequency is less than the switching frequency 1 (F5.02), speed ring PI control parameters for F5.00 and F5.01. Operating frequency is greater than the switching frequency 2 (F5.05), speed in PI control parameters for F5.03 and F5.04. The speed ring PI parameters of switching frequency 1 and switching frequency 2 are for the two groups of PI parameter linear switching, as shown in figure:

Through the set speed regulator proportion coefficient and the integral time, can adjust the speed of the vector control dynamic response characteristics.

Gain take large, quick response, but will produce oscillation; Gain take hours, response lag.

Integral time is too large, slow response, external interference control variation; Integral time hours, reaction speed, small happen oscillation.

Set this value to considering the control stability and response speed, if the factory parameters can't meet the requirements in the factory value based on parameter adjustment, first increase proportion gain to ensure that the system is not oscillation; Then reduced integration time, make the system has faster response, small overshoot and.

Note: if the PI parameters Settings, may lead to excessive speed overshoot. Even in overshoot back occurs when overvoltage fault.

F5.06	Speed loop integral	valid	0	0	☆
-------	---------------------	-------	---	---	---

		invalid	1		
F5.07	Torque limit source under speed control mode	Function code F5.08 setting	0	0	☆
		AI1	1		
		AI2	2		
		Panel potentiometer setting	3		
		High-speed pulse setting	4		
		Communication setting	5		
		Min(AI1, AI2)	6		
		Max(AI1, AI2)	7		
		AI3 setting	8		
F5.08	Upper limit digital setting for lower torque under speed control mode	0.0% to 200.0%		150.0%	☆
<p>In speed control mode, the maximum value of inverter output torque is controlled by the torque upper limit source.</p> <p>F5.07 is used to select the setting source of torque upper limit, when it is set by analog, high-speed pulse or communication, the set 100% corresponds to F5.08, the 100% of F5.08 is the inverter's rated torque.</p>					
F5.09	Vector control differential gain	50% to 200%		150%	☆
<p>For the sensorless vector control, the parameter can be used to adjust the motor speed and stability: if the speed of motor with load is low, increases the parameter and vice versa decreases.</p>					
F5.10	Speed loop filter time constant	0.000s~0.100s		0.000s	☆
<p>Under vector control mode, properly increases the filter time when speed fluctuate wildly; but do not excessively increases, or the lag effect will cause shock.</p>					
F5.11	Vector control overexcitation gain	0~200		64	☆
<p>In the process of the inverter's deceleration, the over-excitation control can suppress the rise of bus voltage to avoid overvoltage fault. The greater overexcitation gain, the stronger the inhibitory effect.</p> <p>For the occasions that the inverter's deceleration easily cause over pressure alarm , the overexcitation gain needs to be improved. But if overexcitation gain is too large, which easily lead to the increase of output current, you need to weigh in practical applications.</p> <p>For the small inertia occasions that the inverter's deceleration will not cause voltage rise, it is recommended to set overexcitation gain as 0; the set value is also suitable for the occasions with braking resistor.</p>					
F5.12	Excitation regulator proportional gain	0~60000		2000	☆
F5.13	Excitation regulator integral gain	0~60000		1300	☆
F5.14	Torque regulator proportional gain	0~60000		2000	☆
F5.15	Torque regulator integral gain	0~60000		1300	☆
<p>The regulator parameters of vector control current loop PI, the parameter will be obtained automatically after performing asynchronous motor parameters comprehensive auto tuning or synchronous motor parameters comprehensive auto tuning and generally do not need to modify it.</p> <p>It is reminded that the dimension that this current loop integral gain adopted is not the integration time, but the direct set integral gain. Therefore, if the setting of current loop PI gain is too large, which may cause the oscillation of entire control loop, in the event of oscillation, you can manually reduce PI proportional gain and integral gain.</p>					

5-2-8. Keyboard and display: F6.00-F6.19

Code	Parameter name	Setting range	Factory	Change
------	----------------	---------------	---------	--------

			setting	limits
F6.00	STOP/RESET key functions	STOP/RESET key is enabled only under keyboard operation mode	0	1 ☆
		STOP/RESET key is enabled under any operation mode	1	
F6.01	Running status display parameters 1	0000 to FFFF		☆

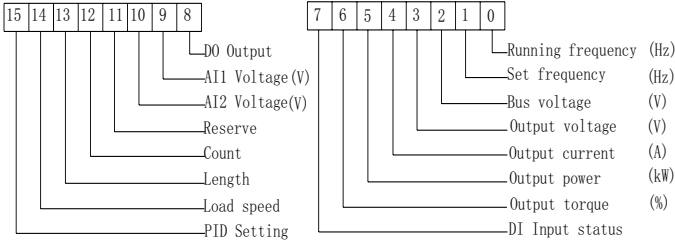

Diagram 5-15: The figure is the Running status 1

If the above parameters need to be displayed in operation, firstly set its position to 1, and then set at F6.01 after converting the binary number to the hexadecimal number.

For example, If the load speed need to be displayed in operation, the 14th in F6.01 should be setting to 1, if the AI voltage need to be displayed in operation, the 9th in F6.01 should be setting to 1. If all of the related position are setting to 1 per the requirement, the data are show as follow:

tag number	15	14	13	12	11	10	9	8	7	6	5	4	3	2	1	0
number	0	1	1	1	1	0	1	0	0	1	0	0	1	1	1	1

The data will divided to 4 group,

tag number	15-12	11-8	7-4	3-0
number	0111	1010	0100	1111

After check the comparison of the binary number and the hexadecimal number. the data is 0x7A4F.

Binary	Hexadecimal	Binary	Hexadecimal	Binary	Hexadecimal	Binary	Hexadecimal
0000	0	0100	4	1000	8	1100	C
0001	1	0101	5	1001	9	1101	D
0010	2	0110	6	1010	A	1110	E
0011	3	0111	7	1011	B	1111	F

F6.02	Running status display parameters 2	0x0000 ~0xFFFF	0000	☆
-------	-------------------------------------	----------------	------	---

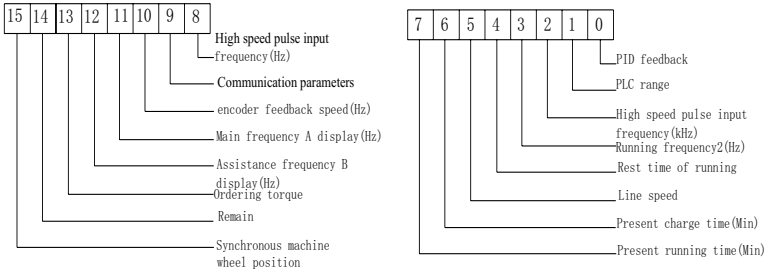

Diagram 5-16:Run display 2

If the above parameters need to be displayed in operation, firstly set its position to 1, and then set at F6.02 after converting the binary number to the hexadecimal number.

Running status display parameters, which is used to set the parameters that can be viewed when the inverter is in operation.

There are 32 parameters available for viewing, select desired status parameters according to F6.01, F6.02 binary parameter values, the display order starts from the lowest level of F6.01.

F6.03	Stop status display parameters	0x0001~0xFFFF	0033	☆
-------	--------------------------------	---------------	------	---

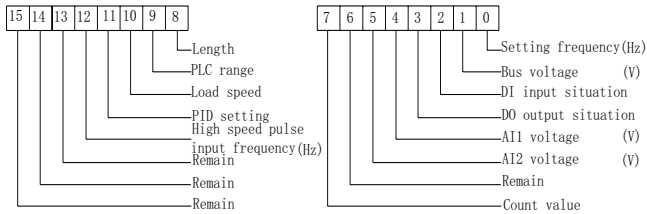

Diagram 5-17:Stop status

If the above parameters need to be displayed on operation, firstly set its position to 1, and then set at F6.03 after converting the binary number to the hexadecimal number.

F6.04	Load speed display coefficient	0.0001~6.5000	3.0000	☆
-------	--------------------------------	---------------	--------	---

When load speed needs to be displayed, adjust the inverter's output frequency and load speed by using the parameter.

Pls refer to the F6.05 for the specific correspondence

F6.05	Decimal places for load speed display	0 decimal place	0	1	☆
		1 decimal place	1		
		2 decimal places	2		
		3 decimal places	3		

Decimal places for load speed display The below example illustrates the calculation of load speed:

If the load speed coefficient(F6.04) is 3.000, the number of decimal places of load speed(F6.05) is 2 (0 decimal places), when the inverter operating frequency reaches 40.00Hz, the load speed is : $40.00 * 3.000 = 1200$ (0 decimal places display).If the inverter is shutdown, the load speed displays the speed relative to the set frequency, that is the "set load speed". If the set frequency is 50.00Hz, the load speed under the state of shutdown: $50.00 * 3.000 = 1500$ (0 decimal places display)

F6.06	Inverter module radiator temperature	0.0°C~100.0°C	-	●
-------	--------------------------------------	---------------	---	---

Display the inverter module IGBT temperature.The different models of the inverter module vary IGBT overtemperature protection values.

F6.07	Total run time	0h~65535h	-	●
-------	----------------	-----------	---	---

Chapter 5 Function parameter

Display the total run time of inverter When the run time reaches the set time(F7.21), the inverter's multi-function digital output function (12) outputs ON signal.				
F6.08	Total power-on time	0~65535h	-	●
Show the total time of inverter power-on, When the power-on time reaches the set time(F7.20), the inverter's multi-function digital output function(24) outputs ON signal.				
F6.09	Total power consumption	0~65535℃	-	●
Display the total power consumption of inverter to date until now				
F6.10	Part number	Inverter product number	-	●
F6.11	Software version number	Control panel software version number	-	●
F6.12~ F6.15	Reserve			
F6.16	Monitor selection 2	1Kbit/100bit	10bit/1bit	d0.04 ●
		parameter number	parameter series number	
The parameter of motor selection2 can be showed in the bottom of double LED or LCD.				
F6.17	Power correction coefficient	0.00~10.00	1.00	☆
Frequency converter with motor running, the display output power(d0.05)is different with the actual output power, through the parameters, adjust the converter display power and the actual output power corresponding relation.				
F6.18	Multifunction key definition 1	UP key is defined as add function key	0	0 ☆
		UP key is defined free stop	1	
		UP key is defined Forward running	2	
		UP key is defined Reverse running	3	
		UP key is defined Forward Jog running	4	
		UP key is defined Reverse Jog running	5	
		UP key is defined UP function key	6	
F6.19	Multifunction key definition 2	DOWN key is defined as subtract function key	0	0 ☆
		Key is defined free stop	1	
		DOWN key is defined Forward running	2	
		DOWN key is defined Reverse running	3	
		DOWN key is defined Forward Jog running	4	
		DOWN key is defined Reverse Jog running	5	
		DOWN key is defined UP function key	6	
<p>DOWN key is defined DOWN function key 7</p> <p>Define the function keys of the user-defined keys 0: The multifunction key define 1 as the add function key. Under the monitor menu, the add function key proceed the add modify of the keyboard setting frequency through F0.01 . Under the parameter selection menu, The add function keys adjust the parameter selection Under the parameter modify menu, the add function keys adjust the parameter value. The multifunction key define 2 as the subtract function key. Under the monitor menu , the subtract function keys proceed the subtract modify of the keyboard setting frequency through F0.01 . Under the parameter selection menu, The subtract function keysadjust the parameter selection Under the parameter modify menu, the subtract function keys adjust the parameter value. 1:Multifunction key is defined free stop key. The key is effective under Parameter selection monitor menu, the inverter is free stop. After free stop , no startup command , after 1S, it is allowed restart . 2:Multifunction key is defined as FWD Forward funning key. Under monitor menu, the key is effective under Parameter selection menu, the inverter is forward running. 3:Multifunction key is defined as FEV reverse running function key. The key is effective under Parameter selection monitor menu, the inverter is forward running.</p>				

Chapter 5

<p>4: Multifunction key is defined as Forward Jog running key. The key is effective under Parameter selection monitor menu, the inverter is forward jog running.</p> <p>5: Multifunction key is defined as Reverse Jog running key. The key is effective under Parameter selection monitor menu, the inverter is reverse jog running.</p> <p>6: Multifunction key is defined as UP function key. The key is effective at any time, the control way is same as terminal control UP.</p> <p>7: Multifunction key is defined as DOWN function key. The key is effective at any time, the control way is same as terminal control UP.</p>					
F6.20	Keyboard lock selection	RUN/STOP key is enabled	0	0	☆
		STOP/RESET/ key and encoder is enabled	1		
		RUN/STOP/UP/DOWN key is enabled	2		
		STOP key is enabled	3		
<p>Pressing the PRG+ Encoder keys to achieve lock and unlock. When the keyboard belongs to the lock state, when the keyboard is locked, the digital display tube will show "A." in front, such as the keyboard on display 50, when the lock, press the keyboard "PGR" key, digital display "A.50.00.</p>					
F6.21	QUICK Function Selection	No function	0	0	☆
		jog running	1		
		shift key	2		
		forward/Reverse running switching	3		
		UP/DOWN setting remove	4		
		Free stop	5		
		commands switch orderly	6		
<p>1:Jog running: press QUICK key, the inverter will make jog running in the default direction. 2:Shift key: Choose displayed parameter circularly under running or stop interface 3:Forward/Reverse running switching: it can complete the request of forward/Reverse running, it is effective under the keyboard command. 4:UP/DOWN setting remove: to remove the settings of the UP/DOWN. 5:Free stop; operate the quick key to stop the inverter. 6:Switch and display the commands orderly by pressing QUICK key, Keyboard setting--terminal setting--communications setting will switch orderly.</p>					

5-2-9. Auxiliary function: F7.00-F7.54

Code	Parameter name	Setting range	Factory setting	Change Limit	
F7.00	Jog running frequency	0.00Hz~F0.19(maximum frequency)	6.00Hz	☆	
F7.01	Jog acceleration time	0.0s~6500.0s	5.0s	☆	
F7.02	Jog deceleration time	0.0s~6500.0s	5.0s	☆	
<p>Defined the inverter's reference frequency and ac/deceleration time when jogging. In operation of Jog, the startup mode is fixed as direct startup mode (F3.00 = 0), the shutdown mode is fixed as deceleration parking mode (F3.07 = 0).</p>					
F7.03	Jog priority	Invalid	0	0	☆
		Valid	1		
<p>This parameter is used to set whether the priority of jog function is active or not. When it is set to active, if the jog command is received by inverter in operation, the inverter will change to jog running status.</p>					
F7.04	Jump frequency 1	0.00Hz~F0.19(maximum frequency)	0.00Hz	☆	
F7.05	Jump frequency 2	0.00Hz~F0.19(maximum frequency)	0.00Hz	☆	
F7.06	Jump frequency range	0.00Hz~F0.19(maximum frequency)	0.00Hz	☆	

When the set frequency is in the jump frequency range, the Actual operating frequency will run at the jump frequency close from the set frequency . The inverter can avoid mechanical resonance point of load by setting jump frequency.

PI500 can set two jump frequency points, if the two jump frequencies are set to 0, the jump frequency function will be canceled. For the principle schematic of jump frequency and its range, please refer to the following figure.

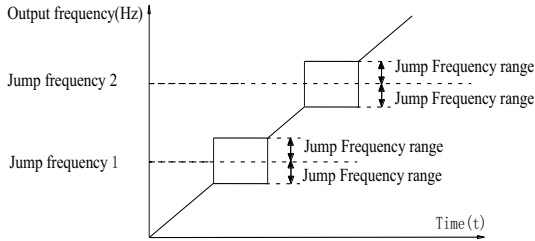

Diagram 5-18:Schematic diagram of jump frequency

F7.07	Jump frequency availability during ac/deceleration process	Invalid	0	☆
		Valid	1	

The function code is used to set whether the jump frequency is active or not in the process of acceleration and deceleration.

If it is set to active, when the operating frequency is in the jump frequency range, the Actual operating frequency will skip the set jump frequency boundary. The below figure below shows the jump frequency status in the process of acceleration and deceleration.

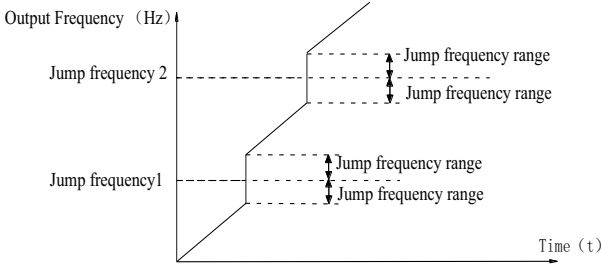

Diagram 5-19:Schematic diagram of jump frequency availability in the process of acceleration and deceleration.

F7.08	Acceleration time 2	0.0s to 6500.0s	-	☆
F7.09	Deceleration time 2	0.0s to 6500.0s	-	☆
F7.10	Acceleration time 3	0.0s to 6500.0s	-	☆
F7.11	Deceleration time 3	0.0s to 6500.0s	-	☆
F7.12	Acceleration time 4	0.0s to 6500.0s	-	☆
F7.13	Deceleration time 4	0.0s to 6500.0s	-	☆

PI500 provides 4 groups of deceleration time, respectively F0.13\F0.14 and the above 3 groups of deceleration time.

The 4 groups of deceleration time are defined exactly the same, please refer to the instructions of F0.13 and F0.14. The 4 groups of deceleration time can be switched through different combinations of the multi-function digital input terminal DI, please refer to the

instructions of function code F1.00 to F1.07 in the attachment 2 for the detailed application methods .

F7.14	Switching frequency point between acceleration time 1 and acceleration time 2	0.00Hz~F0.19(maximum frequency)	0.00Hz	☆
F7.15	Switching frequency point between deceleration time 1 and deceleration time 2	0.00Hz~F0.19(maximum frequency)	0.00Hz	☆

The function is active when motor 1 is selected and DI terminal is not selected to switch between ac/deceleration. It is used to automatically select ac/deceleration time by not DI terminal but the operating frequency range when the inverter is running.

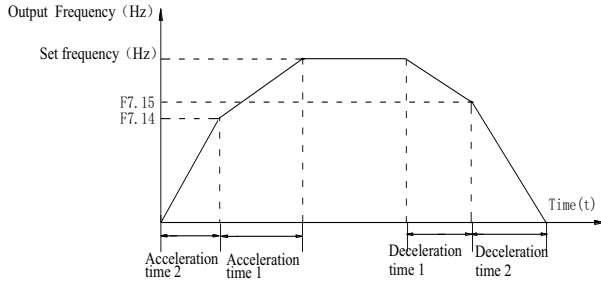

Diagram 5-20: Schematic diagram of switching between acceleration and deceleration

If the operating frequency is less than F7.14, select acceleration time 2; otherwise select acceleration time 1.

For the above figure in the process of deceleration, if the operating frequency is more than F7.15, select deceleration time 1; otherwise select deceleration time 2.

F7.16	Forward/reverse rotation deadband	0.00s~3600.0s	0.0s	☆
-------	-----------------------------------	---------------	------	---

It is the waiting time that the inverter reaches zero speed when the parameter is used to switch between forward and reverse rotation.

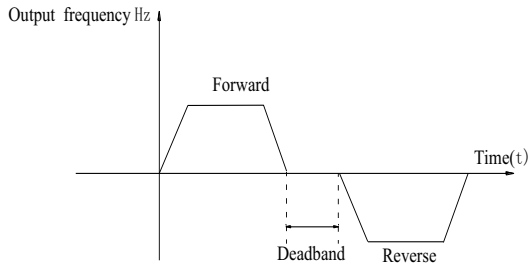

Diagram 5-21: Schematic diagram of the deadband of forward and reverse

F7.17	Reverse rotation control	Allow	0	0	☆
		Prohibit	1		

For certain production equipments, the reverse rotation may result in damage to the equipment, the function can disable the reverse rotation. The factory default allows reverse rotation.

F7.18	Set frequency lower than lower limit frequency mode	Running at lower limit frequency	0	0	☆
		Stop	1		
		Zero speed running	2		

When the set frequency is lower than the lower limit frequency, the inverter operating status can be selected through the parameter. PI500 provides three modes of operation to meet the needs of a variety of applications.

F7.19	Droop control	0.00Hz~10.00Hz	0.00Hz	☆
-------	---------------	----------------	--------	---

Chapter 5 Function parameter

Chapter 5

This function is generally used for the load distribution that multiple motors drag the same one load.

The droop control means that the inverter output frequency is decreased as the load is increased, so that when multiple motors drag(work for)the same one load, each motor's output frequency much drops, which can reduce the load of the motor to balance evenly multiple motors' load .

This parameter means the decreased value of output frequency when the inverter outputs the rated load.

F7.20	Setting cumulative power-on arrival time	0h~36000h	0h	☆
-------	--	-----------	----	---

When the total power-on time(F6.08) reaches the time set by F7.20, the inverter multifunction digital DO outputs ON signal.

F7.21	Setting cumulative running arrival time	0h~36000h	0h	☆
-------	---	-----------	----	---

Used to set the running time of inverter.

When the total power-on time(F6.07) reaches the set timeF7.21, the inverter multifunction digital DO outputs ON signal.

F7.22	Start protection	OFF	0	0	☆
		ON	1		

This parameter relates to the security features of the inverter

If this parameter is set to 1 , and if the running command is active (e.g. the terminal running command is closed before power-on) when the inverter is in power-on, the inverter will not respond to the running command, you must firstly cancel the running command, when the running command is active again, the inverter will respond.

In addition, if the parameter is set to 1, and if the running command is active when the inverter resets fault, the inverter will not respond to the running command, you must firstly cancel the running command in order to eliminate running protection status.

The parameter is set 1, you can prevent the danger caused by that the inverter unknowingly responds to the running command in the event of power-on and fault reset.

F7.23	Frequency detection value (FDT1)	0.00Hz~F0.19(maximum frequency)	50.00Hz	☆
-------	----------------------------------	---------------------------------	---------	---

F7.24	Frequency detection hysteresis value (FDT1)	0.0%~100.0%(FDT1 level)	5.0%	☆
-------	---	-------------------------	------	---

The inverter's multifunction output DO will output ON signal when the operating frequency is higher than the detected value, conversely DO output ON signal is canceled.

The above parameters is used to set the detected value of output frequency, and the hysteresis value after the output is canceled. Of which, F7.24 is the percentage of the hysteresis frequency in the detected value(F7.23). The below figure is the schematic diagram of FDT.

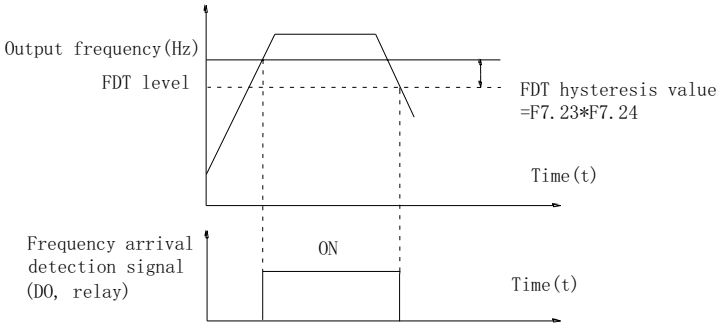

Diagram 5-22:Schematic diagram of FDT level

F7.25	Frequency reaches detection width	0.00~100%(maximum	0.0%	☆
-------	-----------------------------------	--------------------	------	---

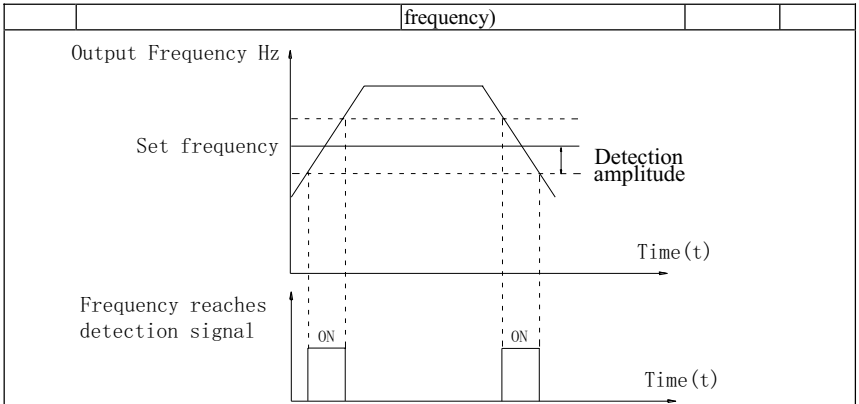

Diagram 5-23: Schematic diagram of frequency arrival detection amplitude

The inverter's multifunction output DO will output ON signal when the inverter's operating frequency is in a certain range of target frequency.

This parameter is used to set the frequency arrival detection range, the parameter is the percentage of maximum frequency. The above figure is the schematic diagram of frequency arrival.

F7.26	Frequency detection value (FDT2)	0.00Hz~F0.19(maximum frequency)	50.00Hz	☆
F7.27	Frequency detection hysteresis value (FDT2)	0.0%~100.0%(FDT2 level)	5.0%	☆
The frequency detection function is same as FDT1 exactly, please refer to the instructions of FDT1 or function codes F7.23, F7.24.				
F7.28	Random arrivals frequency detection value 1	0.00Hz to F0.19 (maximum frequency)	50.00Hz	☆
F7.29	Random arrivals frequency detection width 1	0.00% to 100.0% (maximum frequency)	0.0%	☆
F7.30	Random arrivals frequency detection value 2	0.00Hz to F0.19 (maximum frequency)	50.00Hz	☆
F7.31	Random arrivals frequency detection width 2	0.00% to 100.0% (maximum frequency)	0.0%	☆

When the inverter's output frequency randomly reaches the range of the detected value(positive or negative), the multi-function DO will output ON signal.

PI500 provides two groups of parameter to set frequency value and frequency detection range. The above figure is the schematic diagram of the function.

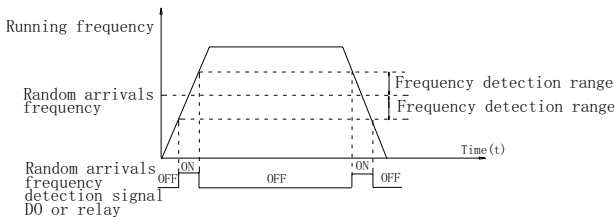

Diagram 5-24: Schematic diagram of random arrivals frequency detection

F7.32	Zero current detection level	0.0%~300.0%(rated motor current)	5.0%	☆
-------	------------------------------	-----------------------------------	------	---

F7.33	Zero current detection delay time	0.01s~360.00s	0.10s	☆
-------	-----------------------------------	---------------	-------	---

Diagram 5-25:Schematic diagram of zero current detection

When the inverter's output current is less than or equal to zero current detection level and lasts for longer than the delay time of zero-current detection, the inverter's multifunction DO will output ON signal. The figure is the schematic diagram of zero current detection.

F7.34	Overrun value of output current	0.0% (not detected) 0.1%~300.0%(rated motor current)	200.0%	☆
F7.35	Output Current overrun detection delay time	0.01s~360.00s	0.00s	☆

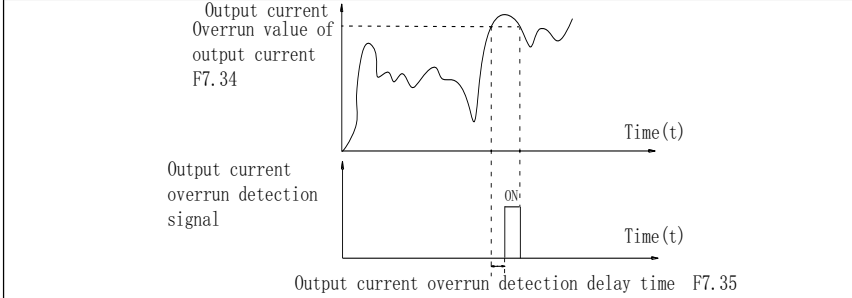

Diagram 5-26:Schematic diagram of output current overrun detection signal

When the inverter's output current is more than or overrun the detection point and lasts for longer than the delay time of software overcurrent point detection, the inverter's multifunction DO will output ON signal.

F7.36	Random arrivals current 1	0.0%~300.0%(rated motor current)	100%	☆
F7.37	Random arrivals current 1 width	0.0%~300.0%(rated motor current)	0.0%	☆
F7.38	Random arrivals current 2	0.0%~300.0%(rated motor current)	100%	☆
F7.39	Random arrivals current 2 width	0.0%~300.0%(rated motor current)	0.0%	☆

When the inverter's output current randomly reaches the range of the current detection width(positive or negative), the inverter multifunction DO will output ON signal.

PI500 provides two group of sets of parameter for Randomly Reaches Current and Detection Width, the figure is the functional diagram.

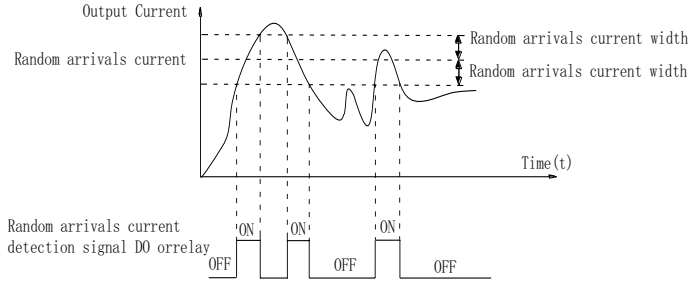

Diagram 5-27:Schematic diagram of random arrivals current detection

F7.40	Module temperature arrival	0°C~100°C	75°C	☆	
When the inverter radiator temperature reaches the temperature, the inverter multifunction DO will output "Module Temperature Arrival" ON signal.					
F7.41	Cooling fan control	Fan running only when running	0	0	☆
		Fan always running	1		
Used to select the cooling fan mode, if you select 0, the fan will run when the inverter is running, but in the stop state of inverter, if the radiator temperature is above 40 degrees, the fan will run, otherwise the fan will not run.If you select 1, when the fan will always running after power-on.					
Noted: The fan of PI500 will be uncontrolled.					
F7.42	Timing function selection	Invalid	0	0	★
		Valid	1		
F7.43	Timing run time selection	F7.44 setting	0	0	★
		A11	1		
		A12	2		
		Panel potentiometer	3		
		Analog input range 100% corresponds to F7.44			
F7.44	Timing run time	0.0Min~6500.0Min	0.0Min	★	
The group of parameters are used to complete the inverter timing run function.					
If F7.42 timing function is active, the inverter starts as the timer starts, when the set timing run time is reached, the inverter automatically shut down, at the same time the multi-function DO will output ON signal.					
Every time the inverter starts, the timer will time from 0, the remaining time can be viewed by d0.20. The timing run time is set by F7.43, F7.44 in minute.					
F7.45	Current running arrival time.	0.0Min~6500.0Min	0.0Min	★	
When current running time reaches this time, the inverter multi-function digital DO will output"Current Running Time Arrival "ON signal.					
F7.46	Awakens frequency	dormancy frequency (F7.48)~ to maximum frequency (F0.19)	0.00Hz	☆	
F7.47	Awakens delay time	0.0s~6500.0s	0.0s	☆	
F7.48	Dormancy frequency	0.00Hz~ awakens frequency (F7.46)	0.00Hz	☆	
F7.49	Dormancy delay time	0.0s~6500.0s	0.0s	☆	
F7.50	A11 input voltage protection lower limit	0.00V~F7.51	3.10V	☆	
F7.51	A11 input voltage protection upper limit	F7.50~10.00V	6.80V	☆	
When analog A11 input is greater than F7.51, or when A11 input is less than F7.50, the inverter multi-functional DO will output "A11 input overrun" signal, so as to indicate whether the A11 input voltage is within the set range or not.					

F7.52 F7.53	Reserve					
F7.54	Jog mode setting	Bits	Jog direction	002	☆	
		Forward				0
		reverse				1
		Determine the direction from the main terminal				2
		Ten bits	End running state by Jogging			
		Restore to the state before jogging				0
		stop running				1
		Hundred bits	Acceleration/deceleration time after stop jogging			
		Recover to the acceleration/deceleration time before jogging				0
		Keep the acceleration/deceleration time when jogging				1

5-2-10. Fault and protection:F8.00-F8.35

Code	Parameter name	Setting range	Factory setting	Change limits	
F8.00	Overcurrent stall gain	0~100	20	☆	
F8.01	Overcurrent stall protection current	100%~200%	150%	☆	
<p>When the inverter output current reaches the set current stall protection current (F8.01), the inverter reduces the output frequency in the acceleration or constant speed operation, while the slow down speed, until the current is less than the current (F8.01).</p> <p>Overcurrent stall gain is used for adjusting inhibition overcurrent capability during ac/deceleration. The greater this value, the stronger inhibition overcurrent capability Under the premise that the overcurrent does not occur, the best is the smaller gain setting.</p> <p>For the small inertia load, the overcurrent stall gain should be small, otherwise which cause the slower system dynamic response. For the big inertia load, the overcurrent stall gain should be large, otherwise the poor inhibitory effect may cause overcurrent fault.</p> <p>When the overcurrent stall gain is set to 0, the overcurrent stall function will be canceled.</p>					
F8.02	Motor overload protection	Prohibit	0	1	☆
		Allow	1		
F8.03	Motor overload protection gain	0.20~10.00	1.00	☆	
<p>F8.02 = 0: no motor overload protection function, there may be the risk of damage to the motor due to overheating, it is recommended that the thermal relay is installed between the inverter and the motor;</p> <p>F8.02 = 1: the inverter will determine whether the motor is overloaded or not according to the inverse time curve of motor overload protection. Inverse time curve of motor overload protection: 220% x (F8.03) x rated motor current, if this lasts for 1 second, the alarm of motor will be prompted overload fault; 150% x (F8.03) x rated motor current, if this lasts for 60 seconds, the alarm of motor overload will be prompted.</p> <p>User shall correctly set the value of F8.03 according to the Actual motor overload capacity, if the value is set to too large , which may easily lead to motor overheating and damage while the inverter will not alarm!</p>					
F8.04	Motor overload pre-alarm coefficient	50%~100%	80%	☆	
<p>This function is used in the front of motor overload fault protection, and sends a pre-alarm signal to the control system by DO. The warning coefficient is used to determine the extent of pre-alarm prior to motor overload protection. The higher the value, the smaller the extent of pre-alarm in advance.</p>					

When the cumulative amount of inverter output current is greater than the product of the inverse time curve of overload and F8.04, the inverter multi-function digital DO will output "Motor Overload Pre-Alarm" ON signal.						
F8.05	Overvoltage stall gain	0(no overvoltage stall) ~100		0	☆	
F8.06	Overvoltage stall protection voltage / energy consumption brake voltage	120%~150%(three-phase)		130%	☆	
In the process of the inverter deceleration, when the DC bus voltage exceeds the overvoltage stall protection voltage/the energy consumption brake voltage, the inverter stops deceleration and maintains at the current operating frequency(if F3.12 is not set to 0, the braking signal is outputted the energy consumption brake can be implemented by an external braking resistor.) and then continues to decelerate upon decline of the bus voltage						
Overvoltage stall gain is used for adjusting inhibition overvoltage capability during deceleration. The greater this value, the stronger inhibition overvoltage capability under the premise that the overvoltage does not occur, the best is the smaller gain setting.						
For the small inertia load, the overvoltage stall gain should be small, otherwise which cause the slower system dynamic response. For the big inertia load, the overvoltage stall gain should be large, otherwise the poor inhibitory effect may cause overvoltage fault.						
When the overvoltage stall gain is set to 0, the overvoltage stall function will be canceled.						
F8.07	Input phase loss protection	Units digit	Input phase loss protection selection		11	☆
		Prohibit		0		
		Allow		1		
		Tens digit	Contactor actuation protection			
		Prohibit		0		
Allow		1				
The input phase loss protection function is only for PI500 G type inverter with 18.5kW or above, not for the F type inverter with 18.5kW or below and however F8.07 is set to 0 or 1.						
F8.08	Output phase loss protection selection	Prohibit		1	☆	
		Allow				
Select whether the output phase loss protection is done or not.						
F8.09	Power-on short circuit to ground	Invalid		1	☆	
		Valid				
You can detect whether the motor is shorted to ground when the inverter is powered on. If this function is active, the inverter's UVW terminal will output voltage after power-on for a while.						
F8.10	Number of automatic fault reset	0~32767		0	☆	
When the inverter selects automatic fault reset, it is used to set the number of times of automatic fault reset. If the set number of times is exceeded, the inverter remains a failed state.						
When set F8.10 (number of automatic fault reset) ≥ 1 , inverter will run automatically when repower after instantaneous power-off.						
When fault self-recovery restart uptime over an hour later, it will restore the original setting of automatic fault reset.						
F8.11	Fault DO action selection during automatic fault reset	OFF		0	☆	
		ON				
If the inverter automatic fault reset function is set, F8.10 can be used to set whether DO action is active or not during the automatic fault reset						
F8.12	Automatic fault reset interval	0.1s~100.0s		1.0s	☆	
It is the waiting time from the inverter fault alarm to automatic fault reset.						
F8.13	Overspeed detection value	0.0%~50.0%(maximum frequency)		20.0%	☆	
F8.14	Overspeed detection time	0.0s~60.0s		1.0s	☆	

Chapter 5 Function parameter

<p>This feature is only available when the inverter runs with speed sensor vector control. When the inverter detects that the actual motor speed exceeds the set frequency, and the excess is greater than the overspeed detection value(F8.13), and the duration is greater than the overspeed detection time(F8.14) the inverter will alarm fault ID Err.43, and troubleshoots according to the protection action.</p>						
F8.15	Detection value for too large speed deviation	0.0%~50.0%(maximum frequency)	20.0%	☆		
F8.16	Detection time for too large speed deviation	0.0s~60.0s	5.0s	☆		
<p>This feature is only available when the inverter runs with speed sensor vector control. When the inverter detects that the actual motor speed is different from the set frequency, and the deviation is greater than the detection value for too large speed deviation(F8.15), and the duration is greater than the detection time for too large speed deviation(F8.16), the inverter will alarm fault ID Err.42, and troubleshoots according to the protection action. If the detection time for too large speed deviation is 0.0s, the detection for too large speed deviation is canceled.</p>						
F8.17	Fault protection action selection 1	Units digit	Motor overload (Fault ID Err.11)		00000	☆
		Free stop		0		
		Stop at the selected mode		1		
		Continue to run		2		
		Tens digit	input phase loss (Err.12) (same as units digit)			
		Hundred digit	output phase loss (Err.13) (same as units digit)			
		Thousand digit	external fault (Err.15) (same as units digit)			
Ten thousands digit	Communication abnormal(Err.16)(same as units digit)					
F8.18	Fault protection action selection 2	Units digit	Encoder fault(Err.20)		00000	☆
		Free stop		0		
		Switch to V/F and then stop at the selected mode		1		
		Switch to V/F and continue to run		2		
		Tens digit	function code read and write abnormal (Err.21)			
		Free stop		0		
		Stop at the selected mode		1		
		Hundreds digit	Reserved			
Thousands digit	Motor overheating (Err.45) (same as F8.17 units digit)					
Ten thousands digit	Running time arrival(Err.26)(same as F8.17 units digit)					
F8.19	Fault protection action selection 3	Units digit	User-defined fault 1(Err.27) (same as F8.17 units digit)		00000	☆
		Tens digit	User-defined fault 2(Err.28) (same as F8.17 units digit)			
		Hundreds digit	Power-on time arrival (Err.29) (same as F8.17 units digit)			
		Thousands digit	Load drop (Err.30)			
		Free stop		0		
		stop at select mode		1		
		Deceleration up to 7% of the rated motor frequency, and then continue running, automatically return to the set frequency to run if the load drop does not happen.		2		
		Ten	PID feedback loss when running (Err.31)			

Chapter 5

		thousands digit	(same as F8.17 units digit)			
F8.20	Fault protection action selection 4	Units digit	Too large speed deviation (Err.42) (same as F8.17 units digit)		00000	☆
		Tens digit	Motor overspeed (Err.43) (same as F8.17 units digit)			
		Hundreds digit	Initial position error (Err.51) (same as F8.17 units digit)			
		Thousands digit	Reserved			
		Ten thousands digit	Reserved			
<p>When "free stop" is selected, the inverter displays Err. *, and directly stops. When "Stop at the selected mode" is selected, the inverter displays Arr. *, firstly stops at the selected mode and then displays Err. * When "continue to run" is selected, the inverter continues to run and displays Arr. *, the operating frequency is set by F8.24.</p>						
F8.21~F8.23	Reserved					
F8.24	Fault running frequency	current frequency running	0	0	☆	
		setting frequency running	1			
		upper frequency running	2			
		down frequency running	3			
		Abnormal reserve frequency running	4			
F8.25	Abnormal reserve frequency	60.0%~100.0%		100%	☆	
<p>When the inverter occurs faults during operation, and the troubleshooting mode for the fault is set to "continue to run", the inverter displays Arr. *, and runs at the operating frequency set by F8.24.</p> <p>When "abnormal spare frequency" is selected, the value set by F8.25 is the percentage of the maximum frequency.</p>						
F8.26	Momentary power cut action selection	Invalid	0	0	☆	
		Deceleration	1			
		Deceleration and stop	2			
F8.27	Frequency switching points for momentary power cut deceleration	50.0%~100.0%		90%	☆	
F8.28	Recovery voltage judgment time of momentary power cut	0.00s~100.00s		0.50s	☆	
F8.29	Judgment voltage of momentary power cut	50.0%~100.0%(standard bus voltage)		80.0%	☆	

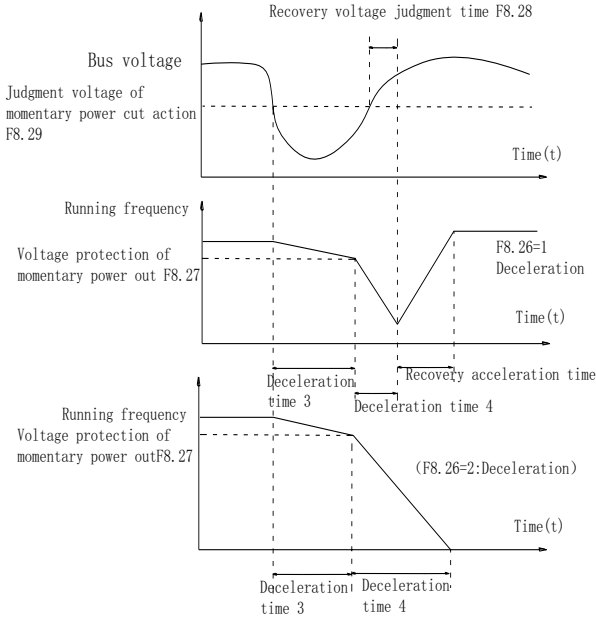

Diagram 5-28:Schematic diagram of momentary power cut action

This feature means that when the momentary power cut happens or the voltage suddenly reduces, the drive will reduce the output speed to compensate the reduced value of the inverter DC bus voltage by using load feedback energy, in order to maintain the inverter to continue running.

If F8.26 = 1, when the momentary power cut happens or the voltage suddenly reduces, the inverter will decelerate, when the bus voltage is back to normal, the inverter will normally accelerate to the set frequency to run. To determine whether the bus voltage returns to normal or not, check whether the bus voltage is normal and lasts for longer than the set time by F8.28.

If F8.26 = 2, when the momentary power cut happens or the voltage suddenly reduces, the inverter will decelerate till to stop.

F8.30	Load drop protection selection	Invalid	0	☆
		Valid	1	
F8.31	Load drop detection level	0.0%~100.0% (Rated current)	10.0%	☆
F8.32	Load drop detection time	0.0s~60.0s	1.0s	☆
<p>If the load drop protection function is active, when the inverter output current is less than the load drop detection level (F8.31) and the duration is longer than the load drop detection time(F8.32), the inverter output frequency is automatically reduced to 7% of the rated frequency. During the load drop protection, if the load recovers, the inverter automatically resumes to the set frequency to run.</p>				
F8.33	motor temperature sensor type	0: Invalid; 1: PT100 detect	0	☆
<p>Motor temperature sensor signal, need to connect to the panel S1, S2, GND terminal.</p>				
F8.34	motor over heat protection value	0~200	110	☆
F8.35	Motor overheating forecasting warning threshold	0~200	90	☆
<p>When the motor temperature more than motor overheating protection valve F8.34, frequency converter fault alarm, and according to the selected fault protection action way. When the motor temperature exceeds motor overheating if forecasting warning threshold F8.35 , inverter multifunction DO early warning ON signal output motor overheating. The motor</p>				

temperature in d0.41 display.

5-2-11. Communication parameter: F9.00-F9.07

Code	Parameter name	Setting range	Factory setting	Change limits							
F9.00	Baud rate	Units digit MODBUS	6005	☆							
		300BPS			0						
		600BPS			1						
		1200BPS			2						
		2400BPS			3						
		4800BPS			4						
		9600BPS			5						
		19200BPS			6						
		38400BPS			7						
		57600BPS			8						
		115200BPS			9						
		Tens digit Profibus-DP			6005	☆					
		115200BPS					0				
		208300BPS					1				
		256000BPS					2				
		512000BPS					3				
		Hundreds digit Reserved					6005	☆			
		Thousands digit CAN bus baudrate							6005	☆	
		20									0
		50									1
100	2										
125	3										
250	4										
500	5										
1M	6										
F9.01	Data format	No parity (8-N-2)	0	☆							
		Even parity (8-E-1)	1								
		Odd parity (8-O-1)	2								
		No parity (8-N-1)	3								
F9.02	This unit address	1~250, 0 for broadcast address	1	☆							
F9.03	Response delay	0ms-20ms	2ms	☆							
F9.04	Communication timeout time	0.0 (invalid), 0.1s-60.0s	0.0	☆							
F9.05	Data transfer format selection	Units igit MODBUS	30	☆							
		Non-standard MODBUS protocol			0						
		Standard MODBUS protocol			1						
		Tens digit Profibus			30	☆					
		PPO1 format					0				
		PPO2 format					1				
		PPO3 format					2				
PPO5 format	3										
F9.06	Communication read current resolution	0.01A	0	☆							
		0.1A	1								
F9.07	Communication card type	Modbus communication card	0	☆							
		Profibus communication card	1								
		Reserved	2								

		CAN bus communication card	3		
--	--	----------------------------	---	--	--

5-2-12. Torque control parameters FA.00-FA.07

Code	Parameter name	Setting range	Factory setting	Change limits	
FA.00	S/T control mode selection	speed control(S)	0	0	★
		torque control (T)	1		
<p>Used to select the inverter control mode: speed control or torque control.</p> <p>PI500 multifunction digital terminal has two related functions on torque control: torque control banned (function 29), and speed control / torque control switching (function 46). The two terminals must use in conjunction with FA.00 so as to switch between speed control and torque control.</p> <p>When the speed control / torque control switching terminal is invalid, the control mode is determined by FA.00, if the terminal is valid, the control manner is equivalent to the FA.00's value negated.</p> <p>In any case, when the torque control ban terminal is valid, the inverter is fixed at speed control mode.</p>					
FA.01	Torque setting source	keyboard setting (FA.02)	0	0	★
		Analog AI1 setting	1		
		Analog AI2 setting	2		
		Panel potentiometer setting	3		
		High-speed pulse setting	4		
		Communications reference	5		
		MIN(AI1,AI2)	6		
		MAX(AI1,AI2)	7		
FA.02	Torque figures set	-200.0%~200.0%	150%	☆	
<p>FA.01 is used to select the torque setting source, there are 9torque setting modes in all.</p> <p>The torque setting adopts the relative value, the 100.0% corresponds to the rated torque of inverter. Setting range is from -200.0% to 200.0%, indicating that the maximum torque of inverter is 2 times of the rated torque of inverter.</p> <p>When the torque setting to a positive, frequency converter operate forwardly, When the torque setting to a negative, inverter operate inversely.</p> <p>When the torque setting adopts mode 1 to 8, the 100% of communications, analog input and pulse input corresponds to FA.02.</p>					
FA.03	Torque control acceleration time	0.00s~650.00s	0.00s	☆	
FA.04	Torque control deceleration time	0.00s~650.00s	0.00s	☆	
<p>Under the torque control mode, the difference between the motor output torque and load torque determines the change rate in speed of the motor and load, therefore, the motor speed may rapidly change, resulting in the problems such as noise or excessive mechanical stress. By setting the torque control ac/deceleration time, you can make a smooth change of motor speed.</p> <p>But the occasions that needs the rapid response of torque, the torque control ac/deceleration time must be set to 0.00s. For example: when two hardwired motors drag the same one load, in order to ensure that the load is evenly distributed, you must set one inverter as the master unit that works under the speed control mode, the other inverter as the auxiliary unit that works under the torque control mode, the Actual output torque of the master unit is used as the torque command of the auxiliary, the torque of the auxiliary needs quickly follow the master unit, so the torque control ac/deceleration time of the auxiliary unit shall be set to 0.00s.</p>					
FA.05	Torque control forward maximum frequency	0.00Hz~maximum frequency (F0.19)	50.00Hz	☆	
FA.06	Torque control backward maximum frequency	0.00Hz~ maximum frequency (F0.19)	50.00Hz	☆	

Used to set the maximum operating frequency of inverter forward or reverse running under the torque control mode				
Under the torque control mode, if the load torque is less than the motor output torque, the motor speed will continue to rise, in order to prevent "Runaway" and other accidents of mechanical systems, it is necessary to limit the maximum speed of motor under the torque control mode.				
FA.07	Torque filter time	0.00s~10.00s	0	☆

5-2-13. Control optimization parameters: Fb.00-Fb.09

Code	Parameter name	Setting range	Factory setting	Change limits
Fb.00	Fast current limiting manner	Disable	0	☆
		enable	1	
Enable Quick Current Limiting function, which can minimize the overcurrent fault of inverter, and ensure the uninterrupted operation of inverter. If the drive is in the state of fast current limiting for a long period of time, the inverter may be damaged by overheating and others, this case is not allowed, so the inverter will alarm fault with fault ID Err.40, it indicates that the inverter exists overload and needs to be shut down.				
Fb.01	Undervoltage point setting	50.0%~140.0%	100.0%	☆
Used to set the voltage value of inverter undervoltage fault with fault ID Err.09, the different voltage levels of inverter 100.0% corresponds to the different voltage points are as follows: Single-phase 220V or three-phase 220V: 200V three-phase 380V: 350V Three-phase 480V: 450V three-phase 690V: 650V				
Fb.02	Oversvoltage point setting	200.0V~2500.0V	-	★
The setting over voltage point of the software has no influence on the setting over voltage point of the hardware. The value of the voltage set to the frequency inverter, different voltage level 's factory defaults are as following:				
		Voltage level	over voltage point factory defaults	
		Single phase 220V	400.0V	
		Three phase 220V	400.0V	
		Three phase 380V	810.0V	
		Three phase 480V	890.0V	
		Three phase 690V	1300.0V	
Remark: Meanwhile, the factory defaults are the upper limit value of over voltage protection in frequency inverter. Only when Fb.02 setting value is smaller than all voltage factory defaults, the new parameter setting takes effect. If it is higher than factory defaults, factory defaults will be the standard value.				
Fb.03	Deadband compensation mode selection	no compensation	0	☆
		compensation mode 1	1	
		compensation mode 2	2	
Generally do not need to modify this parameter, only when the special requirements to the output voltage waveform quality is required or when the motor oscillation and other abnormal happen, you need to try to switch to select a different mode of compensation. The compensation mode 2 for high-power is recommended.				
Fb.04	Current detection compensation	0~100	5	☆
Used to set the inverter's current sensing compensation, if the set value is too large, which may reduce the control performance. Generally do not need to be modified.				
Fb.05	Vector optimization without PG mode selection	no optimization	0	★
		optimization mode 1	1	
		optimization mode 2	2	
Fb.06	Upper limiting frequency	0.00Hz~15.00Hz	12.00H	☆

Chapter 5 Function parameter

	for DPWM switching			z	
Fb.07	PWM modulation manner	asynchronous	0	0	☆
		synchronous	1		
<p>Only valid for V/F control. Synchronous modulation refers to that the carrier frequency linearly change with the change of output frequency, in order to ensure the unchanged of their ratio(carrier to noise ratio), generally it is used when the output frequency is higher, is conducive to ensure the output voltage quality.</p> <p>Under the lower output frequency (100Hz) mode, generally the synchronize modulation is not required, because at the time the ratio of the carrier frequency to the output frequency is relatively high, the asynchronous modulation has more obvious advantages.</p> <p>When the operating frequency is higher than 85Hz, the synchronous modulation takes effect, the fixed mode is the asynchronous modulation below the frequency.</p>					
Fb.08	Random PWM depth	PWM Invalid	0	0	☆
		PWM carrier frequency random depth	1~1 0		
<p>By setting Random PWM, the monotonous and shrill motor sound can become softer and which helps reduce external electromagnetic interference. When Random PWM Depth is set to 0, Random PWM will be invalid.</p> <p>It will get different results by adjusting different Random PWM Depths,</p>					
Fb.09	Deadband time adjustment	100%~200%		150%	☆
<p>About 1140V voltage setting, the voltage availability will be improved by adjust voltage setting. Too lower value setting can lead to system instability. So it is not recommended to revise it for users.</p>					

5-2-14. Extended parameter: FC.00-FC.02

Code	Parameter name	Setting range	Factory setting	Change limits
FC.00	Undefined			
FC.01	Proportional linkage coefficient	0.00~10.00	0	☆
<p>When proportional linkage coefficient is 0, proportional linkage function can not work. According to the setting by proportional linkage, communication address of master (F9.02) is set to 248, and communication address of slave is set to 1 to 247. Slave output frequency = Master setting frequency * Proportional linkage coefficient + UP/DOWN Changes.</p>				
FC.02	PID start deviation	0.0~100.0	0	☆
<p>If the absolute value of deviation between PID setting source and feedback source is greater than of the parameter, the inverter starts only when PID output frequency is greater than the wake-up frequency to prevent the repetition of the inverter starts. If the inverter is operating, when PID feedback source is greater than setting source and the output frequency is less than or equal to (F7.48) sleep frequency, the inverter goes to sleep after (F7.49) delay time and performs free stop.</p> <p>If the inverter is in the state of sleep and the current run command is valid, the absolute value of deviation between PID setting source and feedback source is greater than of PID start deviation (FC.02), when PID setting frequency is greater than or equal to F7.46 wake-up frequency, the inverter will start after (F7.47) delay time.</p> <p>If you want to use the function of PID start deviation, PID stop computing status must be set to active (E2.27 = 1).</p>				

5-2-15. Wobblelate, fixed-length and counting:E0.00-E0.11

Wobblelate function is suitable for the textile, chemical, and other industries, as well as occasions that needs traverse and winding function. Wobblelate function means that the inverter output frequency swings up and down to set the frequency centering around the set frequency, the locus the operating frequency on the timeline is as shown in figure, which the swing amplitude is set by E0.00 and E0.01, when E0.01 is set to 0, the wobblelate will not work.

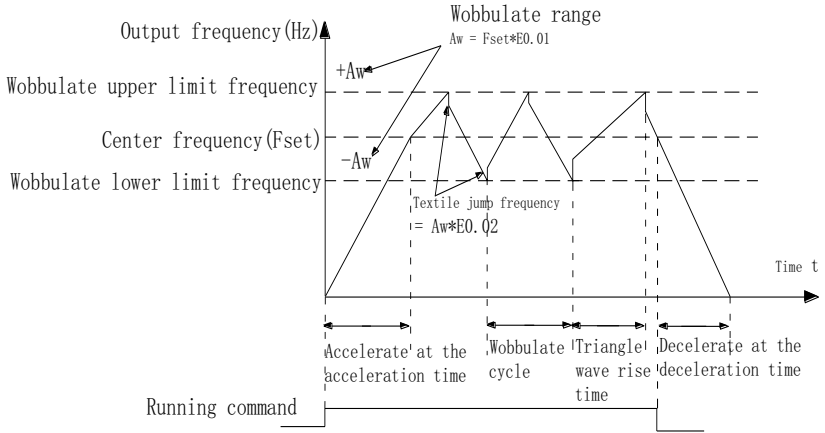

Diagram 5-29: Schematic diagram of wobble operating

Code	Parameter name	Setting range	Factory setting	Change limits
E0.00	Swing setting manner	relative to center frequency	0	☆
		relative to maximum frequency	1	
This parameter is used to determine the baseline of the swing 0: relative to center frequency(F0.07 frequency source).For the variable swing system. The swing varies with the change of center frequency (the set frequency) 1: relative to maximum frequency(F0.19)For the fixed swing system, the swing is fixed.				
E0.01	Wobble range	0.0%~100.0%	0.0%	☆
E0.02	Sudden jump frequency range	0.0%~50.0%	0.0%	☆
The parameter is used to determine the value of swing and the value of sudden jump frequency. When the swing is set to Relative To Center frequency(E0.00=0), Swing (AW) = frequency source (F0.07) × swing amplitude((E0.01). When the swing is set to Relative To Maximum Frequency(E0.00=1), Swing (AW) = maximum frequency (F0.19) × swing amplitude((E0.01). If the sudden jump frequency range is selected for wobble operation, the frequency percentage of sudden jump frequency range relative to swing, i.e.: Sudden jump frequency = Swing(AW)×Sudden jump frequency range(E0.02). When the swing is set to Relative To Center frequency(E0.00=0), the sudden jump frequency is the variable value. When the swing is set to Relative To Middle Frequency(E0.00=1), the sudden jump frequency is the fixed value. The frequency of wobble operation is restricted by the upper and lower frequencies.				
E0.03	Wobble circle	0.1s~3000.0s	10.0s	☆
E0.04	Triangle wave rise time coefficient	0.1%~100.0%	50.0%	☆
Wobble cycle: the time of a complete wobble cycle. Triangle wave rise time coefficient(E0.04), the time percentage of Riangle Wave Rise Time relative to Wobble Cycle(E0.03) Triangle wave rise time = Wobble cycle(E0.03) × Triangle wave rise time coefficient(E0.04), unit: second(s). Triangle wave drop time = Wobble cycle(E0.03) × (1 - Triangle wave rise time coefficient(E0.04)), unit: second(s).				
E0.05	Set length	0m~65535m	1000m	☆
E0.06	Actual length	0m~65535m	0m	☆
E0.07	Pulse per meter	0.1~6553.5	100.0	☆
The above function codes are used to fixed-length control. The length information is sampled through the multi-function digital input terminal, the				

pulse number sampled by terminal divides the pulse per meter(E0.07), so then the Actual length(E0.06) can be computed out. When the Actual length is greater than the set length (E0.05), the multi-functional digital DO will output "Length Arrival" ON signal.

During the fixed-length control, the multifunction DI terminal can be used to reset length (DI function selects 28), please refer to F1.00 to F1.09 for details.

In some applications, the related input terminal function shall be set to "Length Count Input"(function 27), when the pulse frequency is higher, DI5 port must be used .

E0.08	Set count value	1~65535	1000	☆
E0.09	Specified count value	1~65535	1000	☆

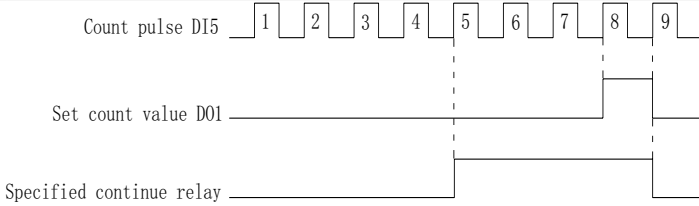

Diagram 5-30:Schematic diagram of the set count value reference and the specified value

The count value needs to be sampled through the multi-function digital input terminal. In some applications, the related input terminal function shall be set to "Counter Input"(function 25), when the pulse frequency is higher, DI5 port must be used .

When the count value reaches the set count value(E0.08), the multifunction digital DO will output "Set Count Value Arrival" ON signal, then the counter stops counting.

When the count value reaches the specified count value(E0.09), the multifunction digital DO will output "Specified Count Value Arrival" ON signal, then the counter continues to count, and then stop till the set count value.

The figure is the schematic diagram of E0.08 = 8 and E0.09 = 4.

E0.10	Reduction frequency pulse number	0: Invalid; 1~65535	0	☆
E0.11	Reduction frequency	0.00Hz~F0.19(max frequency)	5.00Hz	☆

Applications need to the corresponding input terminals function is set to "counter input"(function 25), when set count (E0.08) = count (d0.12) + reduction frequency pulse number (E0.10), the converter automatically slow down to the set reduction frequency (E0.11) run.

Remark: To reset the Count value need to the corresponding input terminals function be set to "counter reset" (function 26)

5-2-16. Multi-stage command, simple PLC: E1.00 - E1.51

Code	Parameter name	Setting range	Factory setting	Change limits
E1.00	0-stage speed setting 0X	-100.0% to 100.0%	0.0%	☆
E1.01	1-stage speed setting 1X	-100.0% to 100.0%	0.0%	☆
E1.02	2-stage speed setting 2X	-100.0% to 100.0%	0.0%	☆
E1.03	3-stage speed setting 3X	-100.0% to 100.0%	0.0%	☆
E1.04	4-stage speed setting 4X	-100.0% to 100.0%	0.0%	☆
E1.05	5-stage speed setting 5X	-100.0% to 100.0%	0.0%	☆
E1.06	6-stage speed setting 6X	-100.0% to 100.0%	0.0%	☆
E1.07	7-stage speed setting 7X	-100.0% to 100.0%	0.0%	☆
E1.08	8-stage speed setting 8X	-100.0% to 100.0%	0.0%	☆
E1.09	9-stage speed setting 9X	-100.0% to 100.0%	0.0%	☆
E1.10	10-stage speed setting 10X	-100.0% to 100.0%	0.0%	☆

E1.11	11-stage speed setting 11X	-100.0% to 100.0%	0.0%	☆
E1.12	12-stage speed setting 12X	-100.0% to 100.0%	0.0%	☆
E1.13	13-stage speed setting 13X	-100.0% to 100.0%	0.0%	☆
E1.14	14-stage speed setting 14X	-100.0% to 100.0%	0.0%	☆
E1.15	15-stage speed setting 15X	-100.0% to 100.0%	0.0%	☆

The multi-stage command can be used as frequency source, can also act as the set source of process PID. The dimension of multi-stage command is the relative values and its range is from -100.0% to 100.0%, when it acts as the frequency source, it is the percentage of maximum frequency; due to the PID reference is originally as a relative value, therefore the multi-stage command acts as the set source of PID and does not need dimension conversion.

The multi-stage command needs to switch according to the different states of multifunction digital DI, please refer to F1 group for specific instructions.

E1.16	Simple PLC running mode	stop after single running	0	0	☆
		hold final value after single running	1		
		circulating	2		

The figure is the schematic diagram of Simple PLC as the frequency source. For Simple PLC as the frequency source, the positive or negative value of E1.00 to E1.15 determines the running direction, the negative value indicates that the inverter runs at the opposite direction.

As the frequency source, PLC operates in three modes, including:

0: stop after single running

After the inverter completes a single cycle, it will automatically shut down, the running command must be given before restart.

1: hold final value after single running

After the inverter completes a single cycle, it will automatically maintain the frequency and direction of the last stage.

2: circulating

After the inverter completes a cycle, it will automatically start next cycle, and stop till the stop command is given.

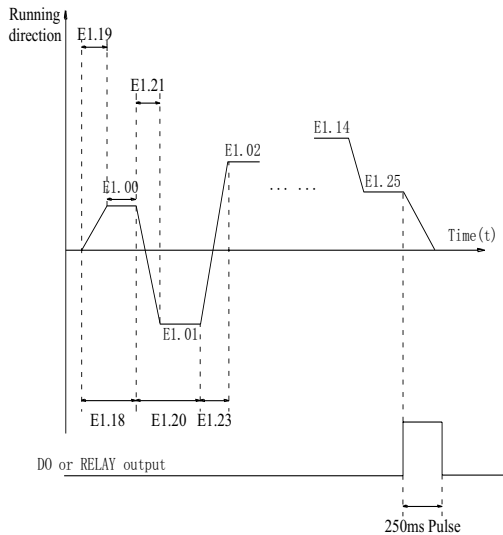

Diagram 5-31: Schematic diagram of simple PLC

E1.17	Simple PLC power-down memory selection	Units digit	power-down memory selection	00	☆
			power-down without memory		

Chapter 5 Function parameter

		power-down with memory	1					
		Tens digit	stop memory selection					
		stop without memory	0					
		stop with memory	1					
<p>PLC "Power-Down With Memory" means that the PLC operating stage and frequency before power-down are memorized, and then it will continue to run from the position of the memorized stage in next power-on. If Power-Down Without Memory is selected, the PLC process will restart from the starting position for each power-on</p> <p>PLC "Stop With Memory" means that the PLC operating stage and frequency before stop are recorded, and then it will continue to run from the position of the recorded stage in next run. If Stop Without Memory is selected, the PLC process will restart from the starting position for each start.</p>								
E1.18	0 stage running time T0	0.0s(h) to 6500.0s(h)	0.0s(h)	☆				
E1.19	0 stage ac/deceleration time selection	0 to 3	0	☆				
E1.20	1 stage running time T1	0.0s(h) to 6500.0s(h)	0.0s(h)	☆				
E1.21	1 stage ac/deceleration time selection	0 to 3	0	☆				
E1.22	2 stage running time T2	0.0s(h) to 6500.0s(h)	0.0s(h)	☆				
E1.23	2 stage ac/deceleration time selection	0 to 3	0	☆				
E1.24	3 stage running time T3	0.0s(h) to 6500.0s(h)	0.0s(h)	☆				
E1.25	3 stage ac/deceleration time selection	0 to 3	0	☆				
E1.26	4 stage running time T4	0.0s(h) to 6500.0s(h)	0.0s(h)	☆				
E1.27	4 stage ac/deceleration time selection	0 to 3	0	☆				
E1.28	5 stage running time T5	0.0s(h) to 6500.0s(h)	0.0s(h)	☆				
E1.29	5 stage ac/deceleration time selection	0 to 3	0	☆				
E1.30	6 stage running time T6	0.0s(h) to 6500.0s(h)	0.0s(h)	☆				
E1.31	6 stage ac/deceleration time selection	0 to 3	0	☆				
E1.32	7 stage running time T7	0.0s(h) to 6500.0s(h)	0.0s(h)	☆				
E1.33	7 stage ac/deceleration time selection	0 to 3	0	☆				
E1.34	8 stage running time T8	0.0s(h) to 6500.0s(h)	0.0s(h)	☆				
E1.35	8 stage ac/deceleration time selection	0 to 3	0	☆				
E1.36	9 stage running time T9	0.0s(h) to 6500.0s(h)	0.0s(h)	☆				
E1.37	9 stage ac/deceleration time selection	0 to 3	0	☆				
E1.38	10 stage running time T10	0.0s(h) to 6500.0s(h)	0.0s(h)	☆				
E1.39	10 stage ac/deceleration time selection	0 to 3	0	☆				
E1.40	11 stage running time T11	0.0s(h) to 6500.0s(h)	0.0s(h)	☆				
E1.41	11 stage ac/deceleration time selection	0 to 3	0	☆				
E1.42	12 stage running time T12	0.0s(h) to 6500.0s(h)	0.0s(h)	☆				
E1.43	12 stage ac/deceleration time selection	0 to 3	0	☆				
E1.44	13 stage running time T13	0.0s(h) to 6500.0s(h)	0.0s(h)	☆				
E1.45	13 stage ac/deceleration time selection	0 to 3	0	☆				
E1.46	14 stage running time T14	0.0s(h) to 6500.0s(h)	0.0s(h)	☆				
E1.47	14 stage ac/deceleration time selection	0 to 3	0	☆				
E1.48	15 stage running time T15	0.0s(h) to 6500.0s(h)	0.0s(h)	☆				
E1.49	15 stage ac/deceleration time selection	0 to 3	0	☆				
<p>Multi-speed operation and deceleration time selection 0 to 3 , corresponding to the function code:</p> <table border="1"> <tr> <td>0: F0.13、F0.14</td> <td>2: F7.10、F7.11</td> </tr> <tr> <td>1: F7.08、F7.09</td> <td>3: F7.12、F7.13</td> </tr> </table>					0: F0.13、F0.14	2: F7.10、F7.11	1: F7.08、F7.09	3: F7.12、F7.13
0: F0.13、F0.14	2: F7.10、F7.11							
1: F7.08、F7.09	3: F7.12、F7.13							

E1.50	Simple PLC run-time unit	S(seconds)	0	0	☆
		H(hours)	1		
E1.51	Multi-stage command 0 reference manner	Function code E1.00 reference	0	0	☆
		Analog AI1 reference	1		
		Analog AI2 reference	2		
		Panel potentiometer setting	3		
		High-speed pulse setting	4		
		PID control setting	5		
		Keyboard set frequency (F0.01) setting, UP/DOWN can be modified	6		
Analog AI3 reference	7				
<p>This parameter determines the multi-stage command 0 reference channel.</p> <p>The multi-stage command 0 not only can select E1.00, but also there are a variety of other options so as to facilitate switching between the multi-stage command and the other reference manner.</p>					

5-2-17. PID function: E2.00-E2.32

PID control is a commonly used method of process control, a closed loop system is formed by the proportional, integral and differential operation of difference between the controlled value feedback signal and target value signal and by adjusting the inverter output frequency so as to stabilize the controlled value at the position of the target value. Suitable for flow control, pressure control and temperature control and other process control applications.

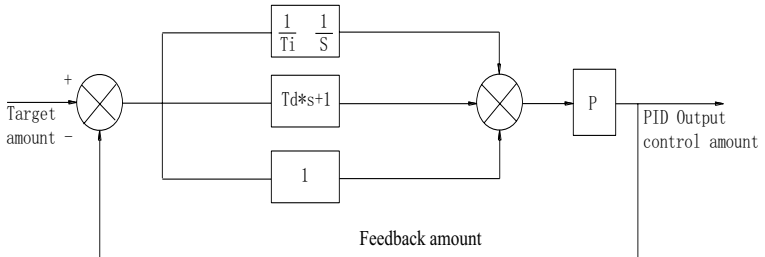

Diagram 5-32:Flow diagram of process PID principle

Code	Parameter name	Setting range	Factory setting	Change limits
E2.00	PID setting source	E2.01 setting	0	☆
		Analog AI1 reference	1	
		Analog AI2 reference	2	
		Panel potentiometer setting	3	
		High-speed pulse setting	4	
		Communications reference	5	
		Multi-stage command reference	6	
E2.01	PID keyboard reference	0.0% to 100.0%	50.0%	☆
<p>This parameter is used to select the process PID target value reference channel.</p> <p>The set target value of process PID is a relative value, the setting range is from 0.0% to 100.0%. The feedback value of PID is also a relative value, the role of PID is to remain the same for the two relative values.</p>				
E2.02	PID feedback source	Analog AI1 reference	0	☆
		Analog AI2 reference	1	

		Panel potentiometer setting	2		
		A11-A12 reference	3		
		High-speed pulse setting	4		
		Communications reference	5		
		A11+A12 reference	6		
		MAX(A11 , A12) reference	7		
		MIN (A11 , A12) reference	8		
		Analog AI3 reference	9		
<p>This parameter is used to select the process PID feedback signal channel. The feedback value of process PID is also a relative value, the setting range is from 0.0% to 100.0%.</p>					
E2.03	PID action direction	Positive	0	0	☆
		negative	1		
E2.04	PID reference feedback range	0 to 65535		1000	☆
<p>PID reference feedback range is a dimensionsless unit for PID setting display(d0.15) and PID feedback display(d0.16).</p> <p>The 100.0% of the relative value of PID reference feedback corresponds to a setting feedback range(E2.04). If E2.04 is set to 2000, when PID setting is 100.0%, PID setting display(d0.15) will be 2000.</p>					
E2.05	PID inversion cutoff frequency	0.00 to F0.19(maximum frequency)		0.00Hz	☆
<p>In some cases, only when the PID output frequency is negative (i.e.the inverter reverses), PID can control the reference value and the feedback value to the same states, but the excessive inversion frequency is not allowed in some occasions, E2.05 is used to the upper limit of determine inversion frequency.</p>					
E2.06	PID deviation limit	0.0% to 100.0%		0.0%	☆
<p>When the deviation between PID reference value and PID feedback value is less than E2.06, PID will stop regulating action. Thus, when the deviation is lesser, the output frequency will be stable, it is especially effective for some closed-loop control occasions.</p>					
E2.07	PID differential limiting	0.00% to 100.00%		0.10%	☆
<p>The role of the differential is more sensitive in PID regulator, is likely to cause system oscillation, generally the role is limited to a smaller range, E2.07 is used to set PID differential output range.</p>					
E2.08	PID reference change time	0.00s to 650.00s		0.00s	☆
<p>The PID reference change time means the required time that PID reference value changes from 0.0% to 100.0%.When the PID reference changes, the PID reference value will change linearly according to the reference change time to reduce the adverse effects to the system caused by a sudden reference change.</p>					
E2.09	PID feedback filter time	0.00s to 60.00s		0.00s	☆
E2.10	PID output filter time	0.00s to 60.00s		0.00s	☆
<p>E2.09 is used for filtering the PID feedback quantity, the filter helps reduce the influence of interference to the feedback quantity, but will bring the response performance of the process closed loop system.</p> <p>E2.10 is used for filtering the PID output frequency, the filter will weaken the sudden change of the inverter output frequency, but it will also bring the response performance of the process closed loop system.</p>					
E2.11	PID feedback loss detection value	0.0%: not judged feedback loss 0.1% to 100.0%		0.0%	☆
E2.12	PID feedback loss detection time	0.0s to 20.0s		0.0s	☆
<p>This function code is used to determine whether the PID feedback is lost or not.</p> <p>When the PID feedback is less than the PID feedback loss detection value(E2.11), and the duration is longer than the PID feedback loss detection time(E2.12), the inverter will alarm fault ID Err.31, and troubleshoot according to the selected method.</p>					
E2.13	Proportional gain KP1	0.0 to 200.0		80.0	☆

E2.14	Integration time Ti1	0.01s to 10.00s	0.50s	☆	
E2.15	Differential time Td1	0.00s to 10.000s	0.000s	☆	
<p>Proportional gain KP1: Used to decide the extent of the PID regulator, the greater KP1, the greater adjusting extent. This parameter 100.0 means that when the deviation of PID feedback value and reference value is 100.0%, the PID regulator will adjust the output frequency command to the maximum frequency.</p> <p>Integration time Ti1: used to decide the extent of integral adjustment of the PID regulator. The shorter integration time, the greater extent of integral adjustment The integration time means that when the deviation of PID feedback value and reference value is 100.0%, the integration regulator will successively adjust to the maximum frequency for the time.</p> <p>Differential time Td1: used to decide the extent that the PID regulator adjusts the deviation change rate. The longer differential time, the greater extent of adjustment The differential time means that the feedback value changes 100.0% within the time, the differential regulator will adjust to the maximum frequency.</p>					
E2.16	Proportional gain KP2	0.0 to 200.0	20.0	☆	
E2.17	Integration time Ti2	0.01s to 10.00s	2.00s	☆	
E2.18	Differential time Td2	0.00s to 10.000s	0.000s	☆	
E2.19	PID parameter switching conditions PID parameter switching deviation 1	no switching	0	0	☆
		switching via terminals	1		
		automatically switching according to deviation.	2		
E2.20	Proportional gain KP2	0.0% to E2.21	20.0%	☆	
E2.21	Integration time Ti2	E2.20 to 100.0%	80.0%	☆	
<p>In some applications, only one group of PID parameters can not meet the needs of the entire run, it is required to use different PID parameters under different conditions.</p> <p>This group of function codes is used to switch between two groups of PID parameters. Which the setting method for regulator parameter(E2.16 to E2.18) is similar to the parameter(E2.13 to E2.15).The two groups of PID parameters can be switched by the multi-functional digital DI terminal, can also be switched automatically according to the PID deviation.If you select the multi-functional DI terminal, the multi-function terminal function selection shall be set to 43 (PID parameter switching terminal), select parameter group 1 (E2.13 E2.15) when the terminal is inactive, otherwise select parameter group 2 (E2.16 to E2.18).</p> <p>If you select the automatic switch mode, and when the absolute value of deviation between reference and feedback parameters is less than PID parameter switching deviation 1(E2.20), select parameter group 1 for PID parameter. When the absolute value of deviation between reference and feedback parameters is more than PID parameter switching deviation 2(E2.21), select parameter group 2 for PID parameter. If the deviation between reference and feedback parameters is between switching deviation 1 and switching deviation 2, PID parameter is the linear interpolation of the two groups of PID parameters , as shown in the figure.</p>					
Diagram 5-33:PID parameter switch					

E2.22	PID integral properties	Units digit	integral separation		00	☆	
		Invalid					0
		Valid					1
		Tens digit	whether stop integration when output reaches limit				
		continue					0
		stop integral			1		

Integral separation: If the integral separation is set to active, when the integral pause of multifunction digital DI(function 38) is active, PID integral will stop operations, at the time only the proportional and derivative actions of PID is active. If the integral separation is set to inactive, however the multifunction digital DI is active or inactive, the integral separation will be inactive. Whether stop integration when output reaches limit: you can select whether or not to stop the integral action after PID operation output reaches the maximum or the minimum value. If you select to stop the integral action, the PID integral will stop the calculation, which may help to reduce the overshoot of PID.

E2.23	PID initial value	0.0%~100.0%(Max frequency)	0.0%	☆
E2.24	PID initial value hold time	0.00s~360.00s	0.00s	☆

When the inverter starts, PID output is fixed at PID initial value(E2.23), and then continuous for the PID initial value hold time(E2.24), at last PID begins operation of the closed-loop adjustment.

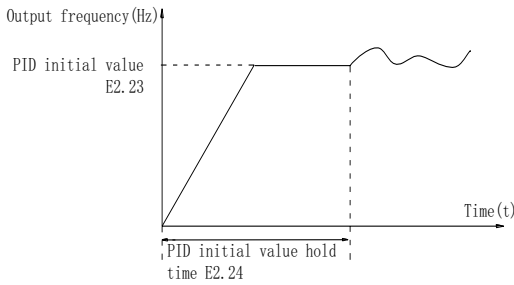

Diagram 5-34: functional schematic of PID initial value.

E2.25	Maximum deviation of twice outputs(forward)	0.00% to 100.00%	1.00%	☆
E2.26	Maximum deviation of twice outputs(backward)	0.00% to 100.00%	1.00%	☆

This function is used to limit the deviation between two PID output beats(2ms/beats), in order to suppress the too fast changes of PID output so that stabilizing the inverter operation.

E2.25 and E2.26 respectively corresponds to the maximum of the absolute value of output deviation when rotating forward and reverse.

E2.27	Computing status after PID stop	stop without computing	0	1	☆
		stop with computing	1		

Used to select whether to continue computing in the state of PID shutdown. Generally, PID will stop computing in the state of shutdown.

E2.28	Reserved				
E2.29	PID automatic deceleration frequency option	Invalid	0	0	☆
		valid	1		

PID feedback value equal to the given value, the inverter frequency is reduced effectively. When PID frequency effectively reduced, frequency converter detection time interval E2.31 reduced frequency, every time decrease frequency of 0.5 Hz, if in the process of reducing frequency feedback value is less than the given value, inverter speed up directly to the set value.

E2.30	PID stop frequency	0Hz to Max frequency (F0.19)	25Hz	☆
-------	--------------------	------------------------------	------	---

The function code only in automatic frequency reduction (E2.29) when selecting effective use.				
Feedback value is greater than the given value of frequency converter, inverter frequency reduction to PID (E2.30) stop frequency, the PID testing number began to count, every PID detection time (E2.31) a number of times, when the count reaches the PID testing number (E2.32), the inverter is slowing down. If in the counting process, feedback value is less than the given value, the inverter directly to accelerate the operation to the set frequency.				
E2.31	PID detection time	0s to 3600s	10	☆
PID frequency effectively reduced, used to detect the time of frequency decline				
E2.32	PID detection number	10 to 500	20	☆
This function relate to the stop frequency setting of PID, the inverter will decelerate and stop when the detective time set reach.				

5-2-18. Virtual DI、Virtual DO: E3.00 - E3.21

Code	Parameter name	Setting range	Factory setting	Change limits
E3.00	Virtual VDI1 terminal function selection	0 to 50	0	★
E3.01	Virtual VDI2 terminal function selection	0 to 50	0	★
E3.02	Virtual VDI3 terminal function selection	0 to 50	0	★
E3.03	Virtual VDI4 terminal function selection	0 to 50	0	★
E3.04	Virtual VDI5 terminal function selection	0 to 50	0	★

Virtual VDI1 ~ VDI5 on the function, are exactly as same as the DI on the control panel, can be used as a multi-function digital quantity input, the details please refer to the F1.00 ~ F1.09 is introduced.

E3.05	Virtual VDI effective status set mode	Units digit	Virtual VDI1	00000	★
		Invalid	0		
		Valid	1		
		Tens digit	Virtual VDI2 (0-1, same as unit digit)		
		Hundreds digit	Virtual VDI3 (0-1, same as unit digit)		
		Thousands digit	Virtual VDI4 (0-1, same as unit digit)		
E3.06	Virtual VDI status set	Ten thousands digit	Virtual VDI5 (0-1, same as unit digit)	11111	★
		Units digit	Virtual VDI1		
		VD1 whether valid is decided by Virtual VDOX status	0		
		VD1 whether valid is decided by Virtual VDOX status	1		
		Tens digit	Virtual VDI2 (0-1, same as unit digit)		
		Hundreds digit	Virtual VDI3 (0-1, same as unit digit)		
		Thousands digit	Virtual VDI4 (0-1, same as unit digit)		
Ten thousands digit	Virtual VDI5 (0-1, same as unit digit)				

Different from ordinary digital quantity input terminals, virtual VDI state can have two setting modes which is selected by E3.06.

When selecting VDI state is determined by the state of the corresponding virtual VDO, VDI is valid or invalid state depending on the VDO output valid or invalid, and VDI_x only binding VDO_x(x=1~5).

When choosing VDI state selection function code to set, through the binary bits of E3.05, respectively determine the state of virtual input terminals.

Example of how to use VDI.

Example 1. Implement following function: “Inverter fault alarm and shuts down when AI1 input exceeds upper or lower frequency”.

Realize by following settings: Set VDI state decided by VDO, set VDI1 function as “user defined fault 1” (E3.00=44); set VDI1 terminal state effective mode decided by VDO1 (E3.06=xxx0); set VDO1 output function as “AI1 input exceeds upper & lower frequency” (E3.11=31); so when AI1 input exceeds upper or lower frequency, VDO1 state is ON, VDI1 input terminal state is effective, VDI1 receive user defined fault 1, inverter then alarm fault no. 27 and shuts down.

Example 2. Implement following function: “Inverter run automatically after power-on”.

Realize by following settings: set VDI state decided by function code E3.05, set VDI1 function as “FORWARD” (E3.00=1); set VDI1 terminal state effective decided by function code (E3.06=xxx1); set VDI1 terminal state is effective (E3.05=xxx1); set command source as “terminal control” (F0.11=1); set protection selection as “no protection” (F7.22=0); so after inverter powered on and initialization complete, VDI1 detected effective, and it match forward running, then inverter starts running forwardly.

E3.07	AI1 terminal as a function selection of DI	0 to 50	0	★	
E3.08	AI2 terminal as a function selection of DI	0 to 50	0	★	
E3.09	reserve				
E3.10	AI terminal as a function selection of DI	Units digit	AI1	000	★
		High level effectively	0		
		High level effectively	1		
		Tens digit	AI2(same as units digit)		
		Hundreds digit	AI3(same as units digit)		

This group function code is used when using AI as DI, when AI used as DI, and input voltage of AI is greater than 7V, AI terminal status will be high level, when input voltage of AI is lower than 3V, AI terminal status will be low level. For between 3V~ 7V hysteresis E3.10 is to determine that when the AI is used as DI, AI is made valid by means of the high level state, or the low level of valid states. As for AI as DI feature set, same as the ordinary DI Settings, please refer to the F1 group setting instructions related DI. Below figure is AI input voltage taken as an example, explains the relationship between input voltage of AI and the corresponding state of DI:

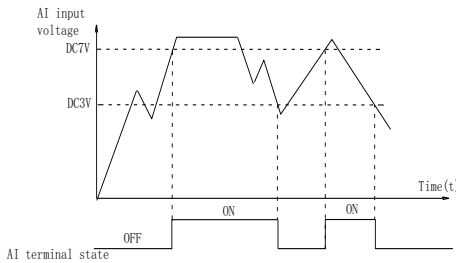

Diagram 5-35: Judgment of effective state of AI

E3.11	VDO1 output function	With the physical internal sub DIx	0	0	☆
		See F2 group physical DO output option	1 to 40		
E3.12	VDO2 output function	With the physical internal sub DIx	0	0	☆
		See F2 group physical DO output option	1 to 40		
E3.13	VDO3 output function	With the physical internal sub DIx	0	0	☆
		See F2 group physical DO output option	1 to 40		
E3.14	VDO4 output function	With the physical internal sub DIx	0	0	☆
		See F2 group physical DO output option	1 to 40		

E3.15	VDO5 output function	With the physical internal sub DIx	0	0	☆
		See F2 group physical DO output option	1 to 40		
E3.16	VDO output effective status	Units digit	VDO1	00000	☆
		Positive logic	0		
		Negative logic	1		
		Tens digit	VDO2(0 to 1, same as above)		
		Hundreds digit	VDO3(0 to 1, same as above)		
		Thousands digit	VDO4(0 to 1, same as above)		
		Ten thousands digit	VDO5(0 to 1, same as above)		
E3.17	VDO1 output delay time	0.0s to 3600.0s	0.0s	☆	
E3.18	VDO2 output delay time	0.0s to 3600.0s	0.0s	☆	
E3.19	VDO3 output delay time	0.0s to 3600.0s	0.0s	☆	
E3.20	VDO4 output delay time	0.0s to 3600.0s	0.0s	☆	
E3.21	VDO5 output delay time	0.0s to 3600.0s	0.0s	☆	
<p>VDO and DO output function is similar, can be used in conjunction with VDIx, to achieve some simple logic control.</p> <p>When VDOx output function is 0, output status is decided by DI1~DI5 input status on the control board, VDOx and DIx one-to-one correspondence.</p> <p>When the output function selection is not 0, VDOx function setting and using method is same as D0 in F2 output parameter, please read F2 group parameter description.</p> <p>The VDOx output valid status can be set by E3.16 setting, select positive logic or anti-logic.</p>					

5-2-19. Motor parameters: b0.00-b0.35

Code	Parameter name	Setting range	Factory setting	Change limits
b0.00	Motor type selection	General asynchronous motor	0	★
		Asynchronous inverter motor	1	
		Permanent magnet synchronous motor	2	
b0.01	Rated power	0.1kW to 1000.0kW	-	★
b0.02	Rated voltage	1V to 2000V	-	★
b0.03	Rated current	0.01A to 655.35A(inverter power≤55kW) 0.1A to 6553.5A(inverter power >55kW)	-	★
b0.04	Rated frequency	0.01Hz to F0.19(maximum frequency)	-	★
b0.05	Rated speed	1rpm to 36000rpm	-	★
<p>Above b0.00 to b0.05 are the motor nameplate parameters, which affects the accuracy of the measured parameters. Please set up according to the motor nameplate parameters. The excellent vector control performance needs the accurate motor parameters. The accurate identification of parameters is derived from the correct setting of rated motor parameters.</p> <p>Above b0.00 to b0.05 are the motor nameplate parameters, which affects the accuracy of the measured parameters. Please set up according to the motor nameplate parameters. The excellent vector control performance needs the accurate motor parameters. The accurate identification of parameters is derived from the correct setting of rated motor parameters.</p> <p>In order to guarantee the control performance, please configure your motor according to the</p>				

Chapter 5 Function parameter

inverter standards, the motor rated current is limited to between 30% to 100% of the inverter rated current. The motor rated current can be set, but can not exceed the inverter rated current. This parameter can be used to determine the inverter's overload protection capacity and energy efficiency for the motor.

In order to guarantee the control performance, please configure your motor according to the inverter standards, the motor rated current is limited to between 30% to 100% of the inverter rated current. The motor rated current can be set, but can not exceed the inverter rated current. This parameter can be used to determine the inverter's overload protection capacity and energy efficiency for the motor.

It is used for the prevention of overheating caused by the self-cooled motor at low speed , or to correct for protecting the motor when the little change of the motor characteristics may affect the changes of the motor capacity.

It is used for the prevention of overheating caused by the self-cooled motor at low speed , or to correct for protecting the motor when the little change of the motor characteristics may affect the changes of the motor capacity.

b0.06	Asynchronous motor stator resistance	0.001Ω to 65.535Ω(inverter power≤55kW) 0.0001Ω to 6.5535Ω(inverter power>55kW)	-	★
b0.07	Asynchronous motor rotor resistance	0.001Ω to 65.535Ω(inverter power≤55kW) 0.0001Ω to 6.5535Ω(inverter power>55kW)	-	★
b0.08	Asynchronous motor leakage inductance	0.01mH to 655.35mH(inverter power≤55kW) 0.001mH to 65.535mH(inverter power>55kW)	-	★
b0.09	Asynchronous motor mutUal inductance	0.01mH to 655.35mH(inverter power≤55kW) 0.001mH to 65.535mH(inverter power>55kW)	-	★
b0.10	Asynchronous motor no-load current	0.01A to b0.03(inverter power≤55kW) 0.1A to b0.03(inverter power>55kW)	-	★

b0.06 to b0.10 are the asynchronous motor parameters, and generally these parameters will not appear on the motor nameplate and can be obtained by the inverter auto tuning. Among which, only three parameters of b0.06 to b0.08 can be obtained by Asynchronous Motor Parameters Still Auto tuning; however, not only all five parameters but also encoder phase sequence and current loop PI parameters can be obtained by Asynchronous Motor Parameters Comprehensive Auto tuning

When modifying the motor's rated power (b0.01) or rated voltage (b0.02), the inverter will automatically calculate and modify the parameter values of b0.06 to b0.10 , and restore these 5 parameters to the motor parameters of commonly used standard Y Series.

If the asynchronous motor parameters auto tuning can not be achieved on-site, you can enter the corresponding above parameters according to the parameters provided by the manufacturer.

b0.11	Synchronous motor stator resistance	0.001Ω to 65.535Ω(inverter power≤55kW) 0.0001Ω to 6.5535Ω(inverter power>55kW)	-	★
b0.12	Synchronous D-axis inductance	0.01mH to 655.35mH(inverter power≤55kW) 0.001mH to 65.535mH(inverter power>55kW)	-	★
b0.13	Synchronous Q-axis inductance	0.01mH to 655.35mH(inverter power≤55kW) 0.001mH to 65.535mH(inverter power>55kW)	-	★
b0.14	Synchronous counter EMF coefficient	0.1V to 6553.5V	-	★
b0.15 to b0.26	Reserve			

b0.27	Motor parameter auto tuning	No operation	0	0	★
		Asynchronous motor parameters still auto tuning	1		
		Asynchronous motor parameters comprehensive auto tuning	2		
		Synchronous motor parameters still auto tuning	11		

		Synchronous motor parameters comprehensive auto tuning	12		
<p>If the motor is able to disengage the load, in order to obtain a better operating performance, you can choose comprehensive auto tuning; otherwise, you can only select parameters still auto tuning. Firstly set the parameter according to load condition, and then press RUN key, the inverter will perform parameters auto tuning. Parameters auto tuning can be performed only under keyboard operation mode, is not suitable for terminal operation mode and communication operation mode.</p> <p>0: no operation, which prohibits parameters auto tuning.</p> <p>1: asynchronous motor parameters still auto tuning</p> <p>Motor type and motor nameplate parameters b0.00 to b0.05 must be set correctly before performing asynchronous motor parameters still auto tuning. The inverter can obtain b0.06 to b0.08 three parameters before performing asynchronous motor parameters still auto tuning.</p> <p>2: asynchronous motor parameters comprehensive auto tuning</p> <p>During asynchronous motor parameters comprehensive auto tuning, the inverter firstly performs parameters still auto tuning, and then accelerates up to 80% of the rated motor frequency according to the acceleration time F0.13, after a period of time, and then decelerates till stop according to the deceleration time F0.14 to end auto tuning.</p> <p>Before performing asynchronous motor parameters comprehensive auto tuning, not only motor type and motor nameplate parameters b0.00 to b0.05 must be set properly, but also encoder type and encoder pulses b0.29, b0.28.</p> <p>For asynchronous motor parameters comprehensive auto tuning, the inverter can obtain b0.06 to b0.10 five motor parameters, as well as the AB phase sequence b0.31 of encoder, vector control current loop PI parameters F5.12 to F5.15.</p> <p>11: synchronous motor parameters still auto tuning</p> <p>Motor type and motor nameplate parameters b0.00 to b0.05 must be set correctly before performing synchronous motor parameter auto tuning with load. For synchronous motor parameters auto tuning with load, the inverter can obtain the initial position angle, and this is the necessary condition of normal operation of synchronous motor, therefore synchronous motor must perform parameters auto tuning for the first installation and before the initial use.</p> <p>12: synchronous motor parameters comprehensive auto tuning</p> <p>During synchronous motor parameters auto tuning without load, the inverter firstly perform parameters auto tuning with load, and then accelerates up to F0.01 according to the acceleration time F0.13, after a period of time, and then decelerates till stop according to the deceleration time F0.14 to end auto tuning. Please note that F0.01 must be set to a non-zero value when performing identification operation.</p> <p>Before performing synchronous motor parameters auto tuning without load, not only motor type and motor nameplate parameters b0.00 to b0.05 must be set properly, but also encoder pulses b0.29, encoder type b0.28, encoder pole-pairs b0.35.</p> <p>For synchronous motor parameter auto tuning without load, the inverter can obtain not only b0.11 to b0.14 motor parameters, as well as encoder information b0.30 b0.31 b0.32, b0.33, vector control current loop PI parameters F5.12 to F5.15.</p> <p>Note: Motor parameter auto tuning can only be operated under keyboard control mode, under terminal and communication control mode the auto tuning function is invalid.</p>					
b0.28	Encoder type	ABZ incremental encoder	0	0	★
		UVW incremental encoder	1		
		Rotational transformer	2		
		Sine and cosine encoder	3		
		Wire-saving UVW encoder	4		
<p>PI500 supports multiple encoder types, the different encoders need different PG card, please correctly choose PG card. Synchronous motor can choose any of the 5 kinds of encoder, asynchronous motors generally only choose ABZ incremental encoder and rotational transformer.</p> <p>PG card is installed, it is necessary to correctly set b0.28 according to the Actual situation, otherwise the inverter may not play correctly.</p>					

Chapter 5 Function parameter

b0.29	Encoder every turn pulse number	1 to 65535	2500	★	
<p>Set ABZ or UVW incremental encoder per rotation pulses. In vector control with PG, we must correct the parameter, otherwise the motor will not run properly</p>					
b0.30	Encoder installation angle	0.00 to 359.90	0.00	★	
<p>Current detection compensation for setting inverter control, if it is set too large which may cause performance degradation. The parameter is only valid to synchronous motors control, and it is valid to ABZ incremental encoder, UVW incremental encoder, rotational transformer, wire-saving UVW encoder, while invalid to sine and cosine encoders. The parameter can be used for obtaining parameters when performing synchronous motor parameters still auto tuning and synchronous motor parameters comprehensive auto tuning, and it is very important to the operation of asynchronous motors, therefore after the asynchronous motor is first installed, the motor parameter auto tuning must be performed for functioning correctly.</p>					
b0.31	ABZ incremental encoder AB phase sequence	Forward	0	0	★
		Reverse	1		
<p>The function code is only valid to ABZ incremental encoder, that is valid only when b0.28 = 0. It is used to set the AB signal phase sequence of ABZ incremental encoder. The function codes are valid for asynchronous motors and synchronous motors, when performing asynchronous motor parameters comprehensive auto tuning or synchronous motor parameters comprehensive auto tuning, the AB phase sequence of ABZ incremental encoder can be obtained.</p>					
b0.32	UVW encoder offset angle	0.00 to 359.90	0.00	★	
b0.33	UVW encoder UVW phase sequence	Forward	0	0	★
		Reverse	1		
<p>The two parameters are valid only for synchronous motor with UVW encoder. The two parameters can be used for obtaining parameters when performing synchronous motor parameters still auto tuning and synchronous motor parameters comprehensive auto tuning, and the two parameters are very important to the operation of asynchronous motors, therefore after the asynchronous motor is first installed, the motor parameter auto tuning must be performed for functioning correctly.</p>					
b0.34	speed feedback PG disconnection detection time	0.0s: OFF	0.0s	★	
		0.1s to 10.0s			
<p>It is used to set encoder disconnection fault detection time, when it is set to 0.0s, the inverter does not detect the disconnection fault of encoder. When the inverter detects a disconnection fault, and the fault lasts for more than b0.34 set time, the inverter gives out Alarm Err.20. message.</p>					
b0.35	Pole-pairs of rotary transformer	1 to 65535	1	★	
<p>The rotary transformer has pole-pairs, the correct pole-pairs parameters must be set when using the kind of encoder.</p>					

5-2-20. Function code management: y0.00-y0.04

Code	Parameter name	Setting range	Factory setting	Change limits	
y0.00	Parameter initialization	No operation	0	0	★
		Restore the factory parameters, not including motor parameters	1		
		Clear history	2		
		Restore default parameter values, including motor parameters	3		
		Backup current user parameters	4		
		Restore user backup parameters	501		

		Clear keyboard storage area	10		
		upload parameter to keyboard storage area 1	11		
		upload parameter to keyboard storage area 2	12		
		download the parameters from keyboard storage 1 area to the storage system	21		
		download the parameters from keyboard storage 2 area to the storage system	22		
<p>1: restore the factory setting, not including motor parameters:after y0.00 is set to 1, most of the inverter function parameters are restored to the factory default parameters, but motor parameters, frequency command decimal point (F0.02), fault recording information, cumulative running time , cumulative power-on time and cumulative power consumption will not be restored.</p> <p>2: clear history:to clear the history of the inverter's fault recording information, cumulative running time , cumulative power-on time and cumulative power consumption.</p> <p>3: restore default parameter values including motor parameters.</p> <p>4: backup current user parameters:backup the parameters set by the current user. Backup all function parameters. It is easy to restore the default settings when user incorrectly adjust parameters.</p> <p>501Restore user backup parameters:Restore previous backup user parameters.</p> <p>10:Clear keyboard storage area:Empty keyboard storage area 1 and keyboard storage area 2</p> <p>11: upload parameter to keyboard storage area 1:Upload the parameters of the inverter to keyboard storage area 1.</p> <p>12: upload parameter to keyboard storage area 2:Upload the parameters of the inverter to the keyboard storage area 2.</p> <p>21: download the parameters from keyboard storage 1 area to the storage system:Download the parameters from keyboard storage 1 to inverter</p> <p>22:download the parameters from keyboard storage 2 area to the storage system:Download the parameters from keyboard storage 2 to inverter</p>					
y0.01	User password	0 to 65535	0		☆
<p>When y0.01 is set to one any non-zero number, the password protection will take effect. You enter the menu for the next time, you must enter the password correctly, otherwise can not view and modify the function parameters, please keep in mind the set user password.</p> <p>When y0.01 is set to 0, the set user password will be cleared, the password protection function is invalid.</p>					
y0.02	Function parameters display properties	Units digit	d group display selection	11111	★
		Not display	0		
		Display	1		
		Tens digit	E group display selection		
		Not display	0		
		Display	1		
		Hundreds digit	b group display selection		
		Not display	0		
		Display	1		
		Thousands digit	y1 group display selection		
		Not display	0		
		Display	1		
		Ten thousands digit	L group display selection		
		Not display	0		
		Display	1		
y0.03	User Parameters display	Units digit:Reserved		00	☆
		Tens digit: User's change parameter display selection			
		0: Not display; 1: Display			
y0.04	Function code	Modifiable	0	0	☆

modification properties	Not modifiable	1	
-------------------------	----------------	---	--

User can set whether function code parameter can be modified or not, so as to prevent the risk that function parameters are altered unexpectedly.

If the function code is set to 0, all function code can be modified; while it is set to 1, all function code can only be viewed, can not be modified.

5-2-21. Fault query:y1.00-y1.30

Code	Parameter name	Setting range	Factory setting	Change limits
y1.00	Type of the first fault	0 to 51	-	●
y1.01	Type of the second fault	0 to 51	-	●
y1.02	Type of the third(at last) fault	0 to 51	-	●

Record the type of the last three faults of inverter, 0 for no fault. Please refer to the related instructions for the possible causes and solutions for each fault code.

Failure type table:

No.	Failure type	No.	Failure type
0	No fault	20	Encoder/PG card abnormal
1	Inverter unit protection	21	Parameter read and write abnormal
2	Acceleration overcurrent	22	Inverter hardware abnormal
3	Deceleration overcurrent	23	Motor short to ground
4	Constant speed overcurrent	24	Reserve
5	Acceleration overvoltage	25	Reserve
6	Deceleration overvoltage	26	Running time arrival
7	Constant speed overvoltage	27	Custom fault 1
8	Control power failure	28	Custom fault 2
9	Undervoltage	29	Power-on time arrival
10	Inverter overload	30	Off load
11	Motor Overload	31	PID feedback loss when running
12	Input phase loss	40	Fast current limiting timeout
13	Output phase loss	41	Switch motor when running
14	Module overheating	42	Too large speed deviation
15	External fault	43	Motor over-speed
16	Communication abnormal	45	Motor overtemperature
17	Contactora abnormal	51	Initial position error
18	Current detection abnormal	-	COF communication failure
19	Motor auto tuning abnormal		

y1.03	Frequency of the third fault	Frequency of the last fault	●																				
y1.04	Current of the third fault	Current of the last fault	●																				
y1.05	Bus voltage of the third	Bus voltage of the last fault	●																				
y1.06	Input terminal status of the third fault	Input terminal status of the last fault, the order is: <table border="1" style="width: 100%; text-align: center;"> <tr> <td>BIT9</td><td>BIT8</td><td>BIT7</td><td>BIT6</td><td>BIT5</td><td>BIT4</td><td>BIT3</td><td>BIT2</td><td>BIT1</td><td>BIT0</td> </tr> <tr> <td>D10</td><td>D19</td><td>D18</td><td>D17</td><td>D16</td><td>D15</td><td>D14</td><td>D13</td><td>D12</td><td>D11</td> </tr> </table> When the input terminal is ON, the corresponding	BIT9	BIT8	BIT7	BIT6	BIT5	BIT4	BIT3	BIT2	BIT1	BIT0	D10	D19	D18	D17	D16	D15	D14	D13	D12	D11	●
BIT9	BIT8	BIT7	BIT6	BIT5	BIT4	BIT3	BIT2	BIT1	BIT0														
D10	D19	D18	D17	D16	D15	D14	D13	D12	D11														

		binary bits is 1, OFF is 0, all DI status is converted to the decimal number for display.																					
y1.07	Output terminal status of the third fault	<p>Output terminal status of the last fault, the order is:</p> <table border="1" style="margin-left: auto; margin-right: auto;"> <tr> <td>BIT4</td><td>BIT3</td><td>BIT2</td><td>BIT1</td><td>BIT0</td> </tr> <tr> <td>REL2</td><td>SPA</td><td>Reserve</td><td>REL1</td><td>SPB</td> </tr> </table> <p>When the output terminal is ON, the corresponding binary bits is 1, OFF is 0, all DI status is converted to the decimal number for display.</p>	BIT4	BIT3	BIT2	BIT1	BIT0	REL2	SPA	Reserve	REL1	SPB	•										
BIT4	BIT3	BIT2	BIT1	BIT0																			
REL2	SPA	Reserve	REL1	SPB																			
y1.08	Reserved																						
y1.09	Power-on time of the third fault	Current power-on time of the last fault	•																				
y1.10	Running time of the third fault	Current running time of the last fault	•																				
y1.11 to y1.12	Reserve																						
y1.13	Frequency of the second fault	Frequency of the last fault	•																				
y1.14	Current of the second fault	Current of the last fault	•																				
y1.15	Bus voltage of the second fault	Bus voltage of the last fault	•																				
y1.16	Input terminal status of the second fault	<p>Input terminal status of the last fault, the order is:</p> <table border="1" style="margin-left: auto; margin-right: auto;"> <tr> <td>BIT9</td><td>BIT8</td><td>BIT7</td><td>BIT6</td><td>BIT5</td><td>BIT4</td><td>BIT3</td><td>BIT2</td><td>BIT1</td><td>BIT0</td> </tr> <tr> <td>D10</td><td>D19</td><td>D18</td><td>D17</td><td>D16</td><td>D15</td><td>D14</td><td>D13</td><td>D12</td><td>D11</td> </tr> </table> <p>When the input terminal is ON, the corresponding binary bits is 1, OFF is 0, all DI status is converted to the decimal number for display.</p>	BIT9	BIT8	BIT7	BIT6	BIT5	BIT4	BIT3	BIT2	BIT1	BIT0	D10	D19	D18	D17	D16	D15	D14	D13	D12	D11	•
BIT9	BIT8	BIT7	BIT6	BIT5	BIT4	BIT3	BIT2	BIT1	BIT0														
D10	D19	D18	D17	D16	D15	D14	D13	D12	D11														
y1.17	Output terminal status of the second fault	<p>Output terminal status of the last fault, the order is:</p> <table border="1" style="margin-left: auto; margin-right: auto;"> <tr> <td>BIT4</td><td>BIT3</td><td>BIT2</td><td>BIT1</td><td>BIT0</td> </tr> <tr> <td>REL2</td><td>SPA</td><td>Reserve</td><td>REL1</td><td>SPB</td> </tr> </table> <p>When the output terminal is ON, the corresponding binary bits is 1, OFF is 0, all DI status is converted to the decimal number for display.</p>	BIT4	BIT3	BIT2	BIT1	BIT0	REL2	SPA	Reserve	REL1	SPB	•										
BIT4	BIT3	BIT2	BIT1	BIT0																			
REL2	SPA	Reserve	REL1	SPB																			
y1.18	Reserved																						
y1.19	Power-on time of the second fault	Current power-on time of the last fault	•																				
y1.20	Running time of the second fault	Current running time of the last fault	•																				
y1.11 to y1.12	Reserve																						
y1.23	Frequency of the first fault	Frequency of the last fault	•																				
y1.24	Current of the first fault	Current of the last fault	•																				
y1.25	Bus voltage of the first fault	Bus voltage of the last fault	•																				
y1.26	Input terminal status of the first fault	<p>Input terminal status of the last fault, the order is:</p> <table border="1" style="margin-left: auto; margin-right: auto;"> <tr> <td>BIT9</td><td>BIT8</td><td>BIT7</td><td>BIT6</td><td>BIT5</td><td>BIT4</td><td>BIT3</td><td>BIT2</td><td>BIT1</td><td>BIT0</td> </tr> <tr> <td>D10</td><td>D19</td><td>D18</td><td>D17</td><td>D16</td><td>D15</td><td>D14</td><td>D13</td><td>D12</td><td>D11</td> </tr> </table>	BIT9	BIT8	BIT7	BIT6	BIT5	BIT4	BIT3	BIT2	BIT1	BIT0	D10	D19	D18	D17	D16	D15	D14	D13	D12	D11	•
BIT9	BIT8	BIT7	BIT6	BIT5	BIT4	BIT3	BIT2	BIT1	BIT0														
D10	D19	D18	D17	D16	D15	D14	D13	D12	D11														

		When the input terminal is ON, the corresponding binary bits is 1, OFF is 0, all DI status is converted to the decimal number for display.											
y1.27	Output terminal status of the first fault	<p>Output terminal status of the last fault, the order is:</p> <table border="1" style="margin-left: auto; margin-right: auto;"> <tr> <td>BIT4</td> <td>BIT3</td> <td>BIT2</td> <td>BIT1</td> <td>BIT0</td> </tr> <tr> <td>REL2</td> <td>SPA</td> <td>Reserve</td> <td>REL1</td> <td>SPB</td> </tr> </table> <p>When the output terminal is ON, the corresponding binary bits is 1, OFF is 0, all DI status is converted to the decimal number for display.</p>	BIT4	BIT3	BIT2	BIT1	BIT0	REL2	SPA	Reserve	REL1	SPB	•
BIT4	BIT3	BIT2	BIT1	BIT0									
REL2	SPA	Reserve	REL1	SPB									
y1.28	Reserved												
y1.29	Power-on time of the first fault	Current power-on time of the last fault	•										
y1.30	Running time of the first fault	Current running time of the last fault	•										

Chapter 6 Troubleshooting

PI500 can provide effective protection when the equipment performance is played fully. The following faults may appear in the process of use, please refer to the following table to analyze the possible causes and then trouble shoot.

In case of damage to the equipment and the reasons that can not solved, please contact with your local dealers/agents, or directly contact with the manufacturers to seek solutions.

6-1. Fault alarm and countermeasures

PI500 can provide effective protection when the equipment performance is played fully. In case of abnormal fault, the protection function will be invoked, the inverter will stop output, and the faulty relay contact of the inverter will start, and the fault code will be displayed on the display panel of the inverter. Before consulting the service department, user can perform self-check , analyze the fault cause and find out the solution according to the instructions of this chapter. If the fault is caused by the reasons as described in the dotted frame, please consult the agents of inverter or directly contact with our company.

No.	Fault ID	Failure type	Possible causes	Solutions
1	Err.01	Inverter unit protection	<ol style="list-style-type: none"> 1.the short circuit of inverter output happens 2.the wiring for the motor and the inverter is too long 3.module overheating 4.the internal wiring of inverter is loose 5.the main control panel is abnormal 6.the drive panel is abnormal. 7.the inverter module is abnormal 	<ol style="list-style-type: none"> 1.eliminate peripheral faults 2.additionally install the reactor or the output filter 3.check the air duct is blocked or not and the fan is working normally or not, and eliminate problems 4.correctly plug all cables 5.seek for technical support
2	Err.02	Acceleration overcurrent	<ol style="list-style-type: none"> 1.the acceleration time is too short 2.manual torque boost or V/F curve is not suitable 3.the voltage is low 4.the short-circuit or earthing of inverter output happens 5.the control mode is vector and without identification of parameters 6.the motor that is rotating is started unexpectedly. 7.suddenly increase the load in the process of acceleration. 8.the type selection of inverter is small 	<ol style="list-style-type: none"> 1.increase acceleration time 2.adjust manual torque boost or V/F curve 3.set the voltage to the normal range 4.eliminate peripheral faults 5.perform identification for the motor parameters 6.select Speed Tracking Start or restart after stopping the motor. 7.cancel the sudden load 8.choose the inverter with large power level
3	Err.03	Deceleration overcurrent	<ol style="list-style-type: none"> 1.the short-circuit or earthing of inverter output happens 2.the control mode is vector and without identification of parameters 3.the deceleration time is too short 	<ol style="list-style-type: none"> 1.eliminate peripheral faults 2.perform identification for the motor parameters 3.increase the deceleration time 4.set the voltage to the normal range 5.cancel the sudden load

No.	Fault ID	Failure type	Possible causes	Solutions
			4.the voltage is low 5.suddenly increase the load in the process of deceleration. 6.didn't install braking unit and braking resistor	6.install braking unit and brake resistor
4	Err.04	Constant speed overcurrent	1.the short-circuit or earthing of inverter output happens 2.the control mode is vector and without identification of parameters 3.the voltage is low 4. whether suddenly increase the load when running 5.the type selection of inverter is small	1.eliminate peripheral faults 2.perform identification for the motor parameters 3.set the voltage to the normal range 4.cancel the sudden load 5.choose the inverter with large power level
5	Err.05	Acceleration overvoltage	1.didn't install braking unit and braking resistor 2.the input voltage is high 3.there is external force to drag the motor to run when accelerating. 4.the acceleration time is too short	1. install braking unit and brake resistor 2.set the voltage to the normal range 3.cancel the external force or install braking resistor. 4.increase acceleration time
6	Err.06	Deceleration overvoltage	1.the input voltage is high 2.there is external force to drag the motor to run when decelerating. 3.the deceleration time is too short 4.didn't install braking unit and braking resistor	1.set the voltage to the normal range 2.cancel the external force or install braking resistor. 3.increase the deceleration time 4.install braking unit and brake resistor
7	Err.07	Constant speed overvoltage	1.there is external force to drag the motor to run when running 2.the input voltage is high	1.cancel the external force or install braking resistor. 2.set the voltage to the normal range
8	Err.08	Control power failure	The range of input voltage is not within the specification	Adjust the voltage to the range of the requirements of specification
9	Err.09	Under voltage fault	1.the momentary power cut 2.the inverter's input voltage is not within the specification 3.the bus voltage is not normal 4.the rectifier bridge and buffer resistance are abnormal 5.the drive panel is abnormal. 6.the control panel is abnormal	1.reset fault 2.adjust the voltage to the normal range 3.seek for technical support
10	Err.10	Inverter overload	1.the type selection of inverter is small 2.whether the load is too large or the motor stall occurs	1.choose the inverter with large power level 2.reduce the load and check the motor and its mechanical conditions
11	Err.11	Motor Overload	1. power grid voltage is too low 2.whether the setting motor	1.check the power grid voltage 2.correctly set this parameter.

No.	Fault ID	Failure type	Possible causes	Solutions
			protection parameters (F8.03) is appropriate or not 3.whether the load is too large or the motor stall occurs	3.reduce the load and check the motor and its mechanical conditions
12	Err.12	Input phase loss	1.the drive panel is abnormal. 2.the lightning protection plate is abnormal 3.the main control panel is abnormal 4.the three-phase input power is not normal	1.replace the drive, the power board or contactor 2.seek for technical support 3.check and eliminate the existing problems in the peripheral line
13	Err.13	Output phase loss	1.the lead wires from the inverter to the motor is not normal 2.the inverter's three phase output is unbalanced when the motor is running 3.the drive panel is abnormal. 4.the module is abnormal	1.eliminate peripheral faults 2.check the motor's three-phase winding is normal or not and eliminate faults 3.seek for technical support
14	Err.14	Module overheating	1.the air duct is blocked 2.the fan is damaged 3.the ambient temperature is too high 4.the module thermistor is damaged 5.the inverter module is damaged	1.clean up the air duct 2.replace the fan 3.decrease the ambient temperature 4.replace the thermistor 5.replace the inverter module
15	Err.15	External equipment fault	Input external fault signal through the multi-function terminal DI	Reset run
16	Err.16	Communication fault	1.the communication cable is not normal 2.the settings for communication expansion card F9.07 are incorrect 3.the settings for communication parameters F9 group are incorrect 4.the host computer is not working properly	1.check the communication cable 2.correctly set the communications expansion card type 3.correctly set the communication parameters 4.check the wiring of host computer
17	Err.17	Contacting fault	1.input phase loss 2.the drive plate and the contact are not normal	1.check and eliminate the existing problems in the peripheral line 2.replace the drive, the power board or contactor
18	Err.18	Current detection fault	1.check Hall device 2.the drive panel is abnormal.	1.replace the drive panel 2.replace hall device
19	Err.19	Motor parameter auto tuning fault	1.the motor parameters was not set according to the nameplate 2.the identification process of	1.correctly set motor parameter according to the nameplate 2.check the lead wire from the inverter to the motor

No.	Fault ID	Failure type	Possible causes	Solutions
			parameter is timeout	
20	Err.20	Disk code fault	1.the encoder is damaged 2.PG card is abnormal 3.the encoder model does not match 4.the encoder connection has error	1.replace the encoder 2.replace the PG card 3.correctly set the encoder model according to the Actual conditions 4.eliminate the line fault
21	Err.21	EEPROM read and write fault	EEPROM chip is damaged	Replace the main control panel
22	Err.22	Inverter hardware fault	1.overvoltage 2.overcurrent	1.eliminate overvoltage fault 2.eliminate overcurrent fault
23	Err.23	Short-circuit to ground fault	Motor short to ground	Replace the cable or motor
26	Err.26	Cumulative running time arrival fault	Cumulative running time arrival fault	Clear history information by using initialization function parameters
27	Err.27	Custom fault 1	Input custom fault 1 signal through the multi-function terminal DI	Reset run
28	Err.28	Custom fault 2	Input custom fault 2 signal through the multi-function terminal DI	Reset run
29	Err.29	Total power-on time arrival fault	Total power-on time reaches the set value	Clear history information by using initialization function parameters
30	Err.30	Load drop fault	The inverter running current is less than F8.31	Confirm whether the load is removed or not or the settings for parameter(F8.31, F8.32) accord with the Actual operating conditions
31	Err.31	PID feedback loss when running fault	PID feedback is less than the set value of E2.11	Check PID feedback signal or set E2.11 to an appropriate value
40	Err.40	Quick current limiting fault	1.whether the load is too large or the motor stall occurs 2.the type selection of inverter is small	1.reduce the load and check the motor and its mechanical conditions 2.choose the inverter with large power level
41	Err.41	Switch motor when running fault	Change current motor through the terminal when the inverter is running	Switch motor after the inverter stops
42	Err.42	Too large speed deviation fault	1.the setting for Too Large Speed Deviation parameters(F8.15, F8.16) is unreasonable. 2.the setting for encoder parameters is incorrect 3.the parameter was not identified	1.reasonably set the detection parameters 2.correctly set encoder parameters 3.perform identification for the motor parameters
43	Err.43	Motor over	1.the parameter was not	1.perform identification for the

No.	Fault ID	Failure type	Possible causes	Solutions
		speed fault	identified 2.the setting for encoder parameters is incorrect 3.the setting for motor overspeed detection parameter(F8.13, F8.14) is unreasonable.	motor parameters 2.correctly set encoder parameters 3.reasonably set the detection parameters
45	Err.45	Motor overtemperature fault	1.the wiring of temperature sensor is loose 2.the motor temperature is too high	1.detect the wiring of temperature sensor wiring and eliminate fault. 2.decrease carrier frequency or take other cooling measures to cool motor
51	Err.51	Initial position error	the deviation between the motor parameters and the actual parameters is too large	reconfirm the correct motor parameters, focus on whether the rated current is set to too small.
-	COF	Communication failure	1.Keyboard interface control board interface; 2.Keyboard or crystal connector; 3.Control board or keyboard hardware damage; 4.Keyboard line is too long, causing the interference.	1. Detection of keyboard interface, control board interface is abnormal. 2.Detect keyboard, crystal joints are abnormal. 3.Replace control board or keyboard. 4. Consult factory, seek help.

6-2. EMC (Electromagnetic Compatibility)

6-2-1. Definition

Electromagnetic compatibility refers to the ability that the electric equipment runs in an electromagnetic interference environment and implements its function stably without interferences on the electromagnetic environment.

6-2-2. EMC standard

In accordance with the requirements of the Chinese national standard GB/T12668.3, the inverter must comply with the requirements of electromagnetic interference and anti- electromagnetic interference.

Our existing products adopt the latest international standards: IEC/EN61800-3: 2004 (Adjustable speed electrical Power drive systems Part 3: EMC requirements and specific test methods), which is equivalent to the Chinese national standards GB/T12668.3. EC/EN61800-3 assesses the inverter in terms of electromagnetic interference and anti-electronic interference. Electromagnetic interference mainly tests the radiation interference, conduction interference and harmonics interference on the inverter (necessary for civil inverter).

Anti-electromagnetic interference mainly tests the conduction immunity, radiation immunity, surge immunity, EFTB(Electrical Fast Transient Burs) immunity, ESD immunity and power low frequency end immunity (the specific test items includes: 1. Immunity tests of input voltage sag, interrupt and change; 2.commutation notch immunity; 3. harmonic input immunity ; 4. input frequency change; 5. input voltage unbalance; 6. input voltage fluctuation). The tests shall be conducted strictly in accordance with the above requirements of IEC/EN61800-3, and our products are installed and used according to the guideline of the Section 7.3 and can provide good electromagnetic compatibility in general industry environment.

6-3. EMC directive

6-3-1. Harmonic effect

The higher harmonics of power supply may damage the inverter. Thus, at some places where the quality of power system is relatively poor, it is recommended to install AC input reactor.

6-3-2. Electromagnetic interference and installation precautions

There are two kinds of electromagnetic interference, one is the interference from electromagnetic noise in the surrounding environment to the inverter, and the other is the interference from the inverter to the surrounding equipment.

Installation Precautions:

- 1) The earth wires of the Inverter and other electric products shall be well grounded;
- 2) The power cables of the inverter power input and output and the cable of weak current signal (e.g. control line) shall not be arranged in parallel but in vertical if possible.
- 3) It is recommended that the output power cables of the inverter shall use shield cables or steel pipe shielded cables and that the shielding layer shall be grounded reliably, the lead cables of the equipment suffering interferences shall use twisted-pair shielded control cables, and the shielding layer shall be grounded reliably.
- 4) When the length of motor cable is longer than 30 meters, it needs to install output filter or reactor.

6-3-3. Remedies for the interference from the surrounding electromagnetic equipment to the inverter

Generally the electromagnetic interference on the inverter is generated by plenty of relays, contactors and electromagnetic brakes installed near the inverter. When the inverter has error action due to the interference, the following measures is recommended:

- 1) Install surge suppressor on the devices generating interference;
- 2) Install filter at the input end of the inverter, please refer to Section 6.3.6 for the specific operations.
- 3) The lead cables of the control signal cable of the inverter and the detection line shall use the shielded cable and the shielding layer shall be grounded reliably.

6-3-4. Remedies for the interference from the inverter to the surrounding electromagnetic equipment

These noise interference are classified into two types: one is the radiation interference of the inverter, and the other is the conduction interference of the inverter. These two types of interference cause that the surrounding electric equipment suffer from the affect of electromagnetic or electrostatic induction. Further, the surrounding equipment produces error action. For different interference, please refer to the following remedies:

1) Generally the meters, receivers and sensors for measuring and testing have more weak signals. If they are placed nearby the inverter or together with the inverter in the same control cabinet, they easily suffer from interference and thus generate error actions. It is recommended to handle with the following methods: away from the interference source as far as possible; do not arrange the signal cables with the power cables in parallel and never bind them together; both the signal cables and power cables shall use shielded cables and shall be well grounded; install ferrite magnetic ring (with suppressing frequency of 30 to 1,000MHz) at the output side of the inverter and wind it 2 to 3 turns; install EMC output filter in more severe conditions.

2) When the interfered equipment and the inverter use the same power supply, it may cause conduction interference. If the above methods cannot remove the interference, it shall install EMC filter between the inverter and the power supply (refer to Section 6.3.6 for the selection operation);

3) The surrounding equipment shall be separately grounded, which can avoid the interference caused by the leakage current of the inverter's grounding wire when common grounding mode is adopted.

6-3-5. Remedies for leakage current

There are two forms of leakage current when using the inverter. One is leakage current to the

earth, and the other is leakage current between the cables.

1) Factors of affecting leakage current to the earth and its solutions:

There are the distributed capacitance between the lead cables and the earth. The larger the distributed capacitance, the larger the leakage current; the distributed capacitance can be reduced by effectively reducing the distance

between the inverter and the motor. The higher the carrier frequency, the larger the leakage current. The leakage current can be reduced by reducing the carrier frequency. However, the carrier frequency reduced may result in

the increase of motor noise. Please note that additional installation of reactor is also an effective method to solve leakage current problem.

The leakage current may increase with the increase of circuit current. Therefore, when the motor power is higher, the corresponding leakage current will be higher too.

2) Factors of producing leakage current between the cables and its solutions:

There is the distributed capacitance between the output cables of the inverter. If the current passing lines has higher harmonic, it may cause resonance and thus result in leakage current. If the thermal relay is used, it may generate error action.

The solution is to reduce the carrier frequency or install output reactor. It is recommended that the thermal relay shall not be installed in the front of the motor when using the inverter, and that electronic over current protection function of the inverter shall be used instead.

6-3-6. Precautions on installing EMC input filter at the input end of power supply

1) Note: when using the inverter, please follow its rated values strictly. Since the filter belongs to Classification I electric appliances, the metal enclosure of the filter and the metal ground of the installing cabinet shall be well earthed in a large area, and have good conduction continuity, otherwise there may be danger of electric shock and the EMC effect may be greatly affected. Through the EMC test, it is found that the filter ground end and the PE end of the inverter must be connected to the same public earth end, otherwise the EMC effect may be greatly affected.

2) The filter shall be installed at a place close to the input end of the power supply as much as possible.

Chapter 7 Dimension

7-1. Dimension

7-1-1. Product outside drawing, installation size

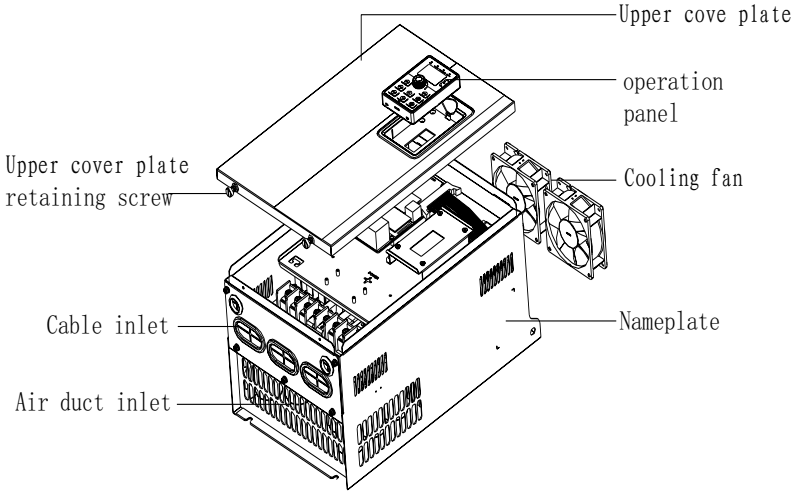

Drawing 7-1:Product outside drawing, installation dimension

7-1-2. PI500 series

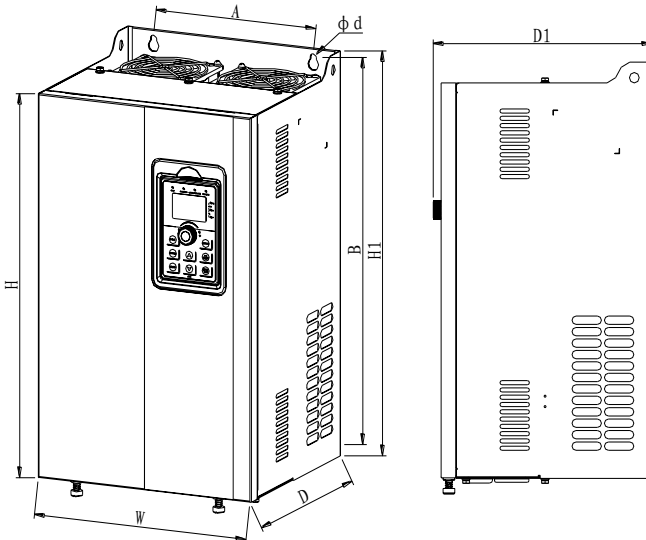

Drawing 7-2:8.5-200kW dimension

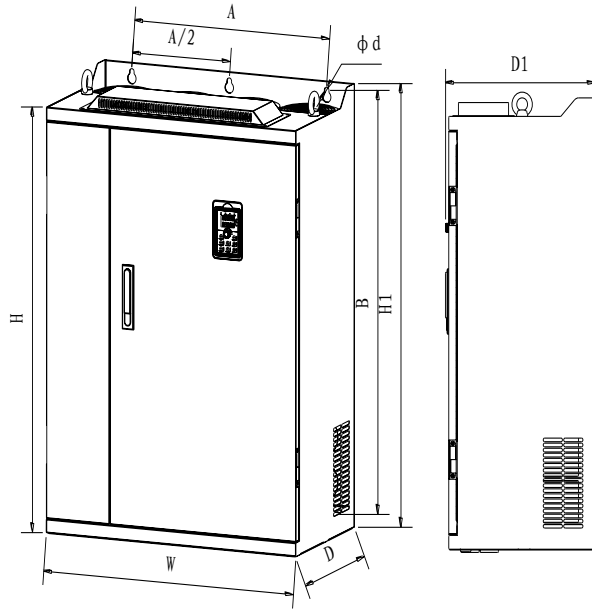

Drawing 7-3:250kW~400kWdimension

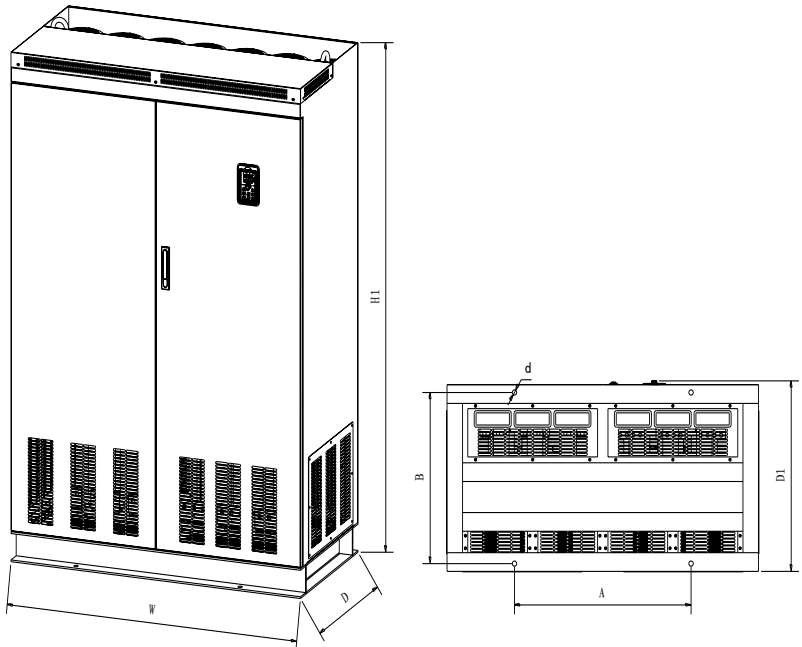

Drawing 7-4:450kW~630kWdimension

Power rating	Output power (kW)	Input current (A)	Output current (A)	Dimension(mm)					Installation dimension (mm)		
				H	H1	W	D	D1	A	B	d
PI500-7R5G3/011F3	7.5/11	20.5/26	17/25	280	300	190	190	198	140	285	6
PI500-011G3/015F3	11/15	26/35	25/32								
PI500-015G3/018F3	15/18.5	35/38.5	32/37								
PI500-018G3/022F3	18.5/22	38.5/46.5	37/45	330	350	210	190	198	150	335	6
PI500-022G3/030F3	22/30	46.5/62	45/60								
PI500-030G3/037F3	30/37	62/76	60/75	380	400	240	215	223	180	385	7
PI500-037G3/045F3	37/45	76/91	75/90								
PI500-045G3/055F3	45/55	91/112	90/110								
PI500-055G3/075F3	55/75	112/157	110/150	500	520	300	275	283	220	500	10
PI500-075G3	75	157	150								
PI500-093F3	90	180	176								
PI500-093G3/110F3	90/110	180/214	176/210	550	575	355	320	328	250	555	10
PI500-110G3/132F3	110/132	214/256	210/253								
PI500-132G3/160F3	132/160	256/307	253/304	695	720	400	360	368	300	700	10
PI500-160G3/187F3	160/187	307/345	304/340								
PI500-187G3/200F3	187/200	345/385	340/380	790	820	480	360	368	370	800	11
PI500-200G3/220F3	200/220	385/430	380/426								
PI500-220G3	220	430	426								
PI500-250F3	250	468	465	940	980	705	380	388	550	945	13
PI500-250G3/280F3	250/280	468/525	465/520								
PI500-280G3/315F3	280/315	525/590	520/585								
PI500-315G3/355F3	315/355	590/665	858/650								
PI500-355G3/400F3	355/400	665/785	650/725								
PI500-400G3	400	785	725								
PI500-450F3	450	883	820								
PI500-450G3/500F3	450/500	883/920	820/860	/	1700	1200	600	612	680	550	17
PI500-500G3/560F3	500/560	920/1010	860/950								
PI500-560G3/630F3	560/630	1010/1160	950/1100								
PI500-630G3/700F3	630/700	1160/1310	1100/1250								

Note:Product dimension after installed eye screw: H1 + 15mm.

7-1-3. Keypad dimension drawing

PI500 Keyboard dimension:

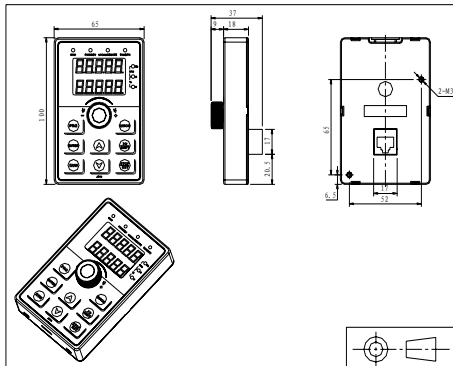

Drawing 7-5:PI500 Keyboard dimension (mm)

PI500 Keyboard frame dimension

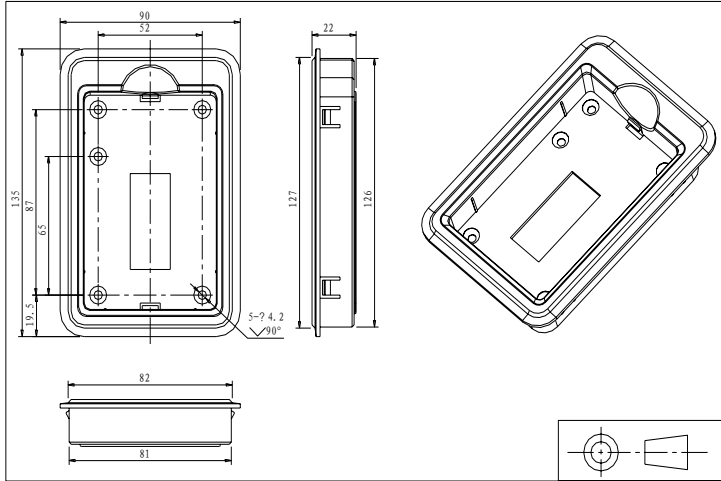

Drawing 7-6:PI500 Keyboard dimension (mm)

PI500 Keyboard installation open inlet dimension

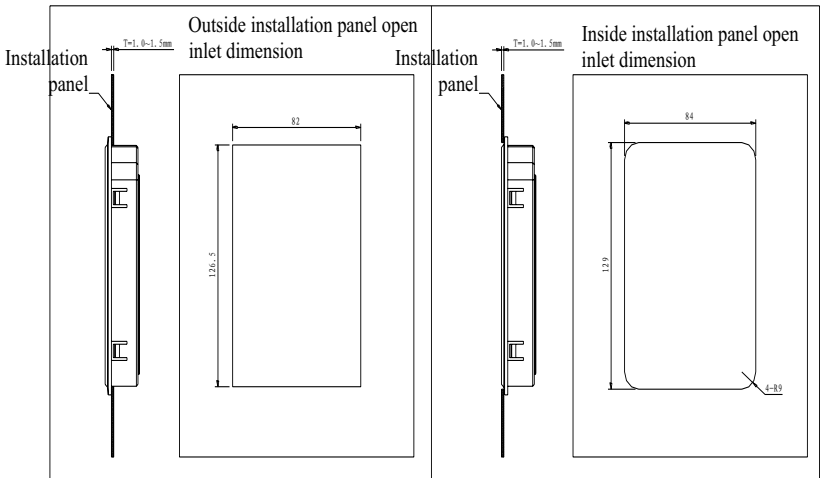

Drawing 7-7:PI500 keyboard installation open inlet dimension(mm)

Chapter 8 Maintenance and Repair

8-1. Inspection and Maintenance

During normal use of the inverter, in addition to routine inspections, the regular inspections are required (e.g. the overhaul or the specified interval, and the interval shall not exceed 6 months), please refer to the following table to implement the preventive measures.

Check Routine	Date Regular	Check Points	Check Items	Check to be done	Method	Criterion
√		Display	LED display	Whether display is abnormal or not	Visually check	As per use status
√	√	Cooling system	Fan	Whether abnormal noise or vibration exists or not	Visually and audibly check	No abnormal
√		Body	Surrounding conditions	Temperature, humidity, dust, harmful gas.	Visually check with smelling and feeling	As per Section 2-1
√		Input/output terminals	Voltage	Whether input/output voltage is abnormal or not	Test R, S, T and U, V, W terminals	As per standard specifications
		√ Main circuit	Overall	Whether these phenomenon of loose fastenings, overheat, discharging, much dust, or blocked air duct exist or not	Visually check, tighten and clean	No abnormal
			Electrolytic capacitance	Whether appearance is abnormal or not	Visually check	No abnormal
			Wires and conducting bar	Whether they are loose or not	Visually check	No abnormal
			Terminals	If screws or bolts are loose or not	Tighten	No abnormal

"√" means routine or regular check to be needed

Do not disassemble or shake the device gratuitously during check, and never unplug the connectors, otherwise the system will not run or will enter into fault state and lead to component failure or even damage to the main switching device such as IGBT module.

The different instruments may come to different measurement results when measuring. It is recommended that the pointer voltmeter shall be used for measuring input voltage, the rectifier voltmeter for output voltage, the clamp-on ammeter for input current and output current, and the electric wattmeter for power.

8-2. Parts for regular replacement

To ensure the reliable operation of inverter, in addition to regular care and maintenance, some internal mechanical wear parts(including cooling fan, filtering capacitor of main circuit for energy storage and exchange, and printed circuit board) shall be regularly replaced. Use and replacement for such parts shall follow the provisions of below table, also depend on the specific application environment, load and current status of inverter.

Name of Parts	Standard life time
Cooling fan	1 to 3 years
Filter capacitor	4 to 5 years
Printed circuit board(PCB)	5 to 8 years

8-3. Storage

The following actions must be taken if the inverter is not put into use immediately(temporary or long-term storage) after purchasing:

- ※ It should be store at a well-ventilated site without damp, dust or metal dust, and the ambient temperature complies with the range stipulated by standard specification
- ※ Voltage withstand test can not be arbitrarily implemented, it will reduce the life of inverter. Insulation test can be made with the 500-volt megger before using, the insulation resistance shall not be less than 4MΩ.

8-4. Capacitor

8-4-1. Capacitor rebuilt

If the frequency inverter hasn't been used for a long time, before using it please rebuilt the DC bus capacitor according the instruction. The storage time is counted from delivery.

Time	Operation instruction
Less than 1 year	No need to recharge
Between 1~2 years	Before the first time to use, the frequency inverter must be recharged for one hour
Between 2~3years	Use adjustable power to charge the frequency inverter: --25% rated power 30 minutes, -- 50% rated power 30minutes, -- 75% rated power 30minutes, --Last 100% rated power 30minutes,
More than 3 years	Use adjustable power to charge the frequency inverter: --25% rated power 2hours, --50% rated power 2 hours, -- 75% rated power 2hours, -- Last 100% rated power 2hours.

Instruction of using adjustable power to charge the frequency inverter:

The adjustable power is decided by the frequency inverter input power, for the single phase/3 phase 220v frequency inverter, we use 220v AC/2A Regulator. Both single phase and three phase frequency inverter can be charged by single phase Power Surge(L+ connect R,N connects T) Because it is the same rectifier, so al l the DC bus capacitor will be charged at the same time.

You should make sure the voltage(380v) of high voltage frequency inverter, because when the capacitor being charged it almost doesn't need any current, so small capacitor is enough(2A)

The instruction of using resisor(incandescent lights) to charge frequency inverters:

When charge the DC bus capacitor of drive system by connecting power directly, then the time should not be less than 60 minutes. The operation should be carried on under the condition of normal temperature and without load, and moreover ,should be added resistor in the power supply cycle.

380V drive system: use 1K/100W resistor. When the power is less than 380v, 100w incandescent lights is also suitable. When using incandescent lights, the lights will extinct or become very weak.

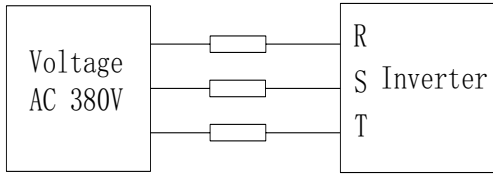

Drawing 8-1:380V Drive equipment charging circuit example

8-5. Measuring and readings

- ※ If a general instrument is used to measure current, imbalance will exist for the current at the input terminal. Generally, the deviation is not more than 10%, that is normal. If the deviation exceeds 30%, please inform the original manufacturer to replace rectifier bridge, or check if the deviation of three-phase input voltage is above 5V or not.
- ※ If a general multi-meter is used to measure three-phase output voltage, the reading is not accurate due to the interference of carrier frequency and it is only for reference.

Chapter 9 Options

User can additionally install peripheral devices based on the different application conditions and requirements for this series of product, and its wiring diagram is as follows:

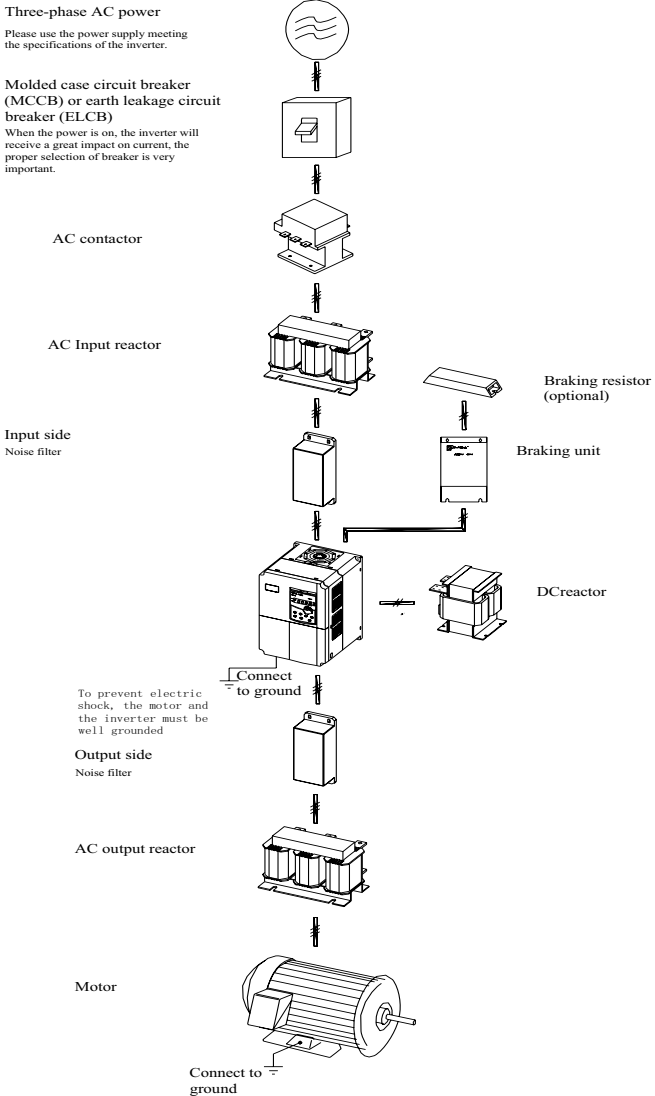

Drawing 9-1:Wiring of optional accessories.

9-1. Expansion cards

If the extended function (RS485 card, PG card, Canbus card, etc.)for other functional modules is needed, please specify the functional module card you want when ordering.

9-2. AC input reactor

AC input reactor can inhibit high harmonics of the inverter input current, significantly improving power factor of the inverter. It is recommended that AC input reactor should be used in the following cases.

- ※ The ratio of the capability of power supply used for the inverter to the inverter own capability is more than 10:1.
- ※ The thyristor load or the device of power-factor compensation with ON/OFF is connected with the same power supply.
- ※ The degree of unbalance for three-phase power supply voltage is larger ($\geq 3\%$).
- ※ Dimensions for common specifications of AC input reactor are as follows:

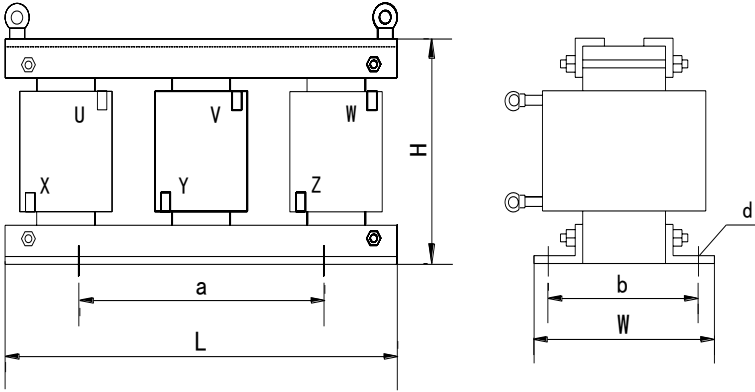

Drawing 9-2:AC input choke dimension

9-2-1. AC Input Choke

Item No.	Model	Power rating (kW)	Rated current (A)	N.W. (kg)	Voltage reduction (V)	Inductance (mH)	Installation dimension a/b/d(mm)
380V voltage series							
1	ACL-0005-EISC-E3M8B	1.5	5	2.48	2.00%	2.8	91/65/6*11
2	ACL-0007-EISC-E2M5B	2.2	7	2.58	2.00%	2.0	91/65/6*11
3	ACL-0010-EISC-E1M5B	4.0	10	2.67	2.00%	1.4	91/65/6*11
4	ACL-0015-EISH-E1M0B	5.5	15	3.45	2.00%	0.93	95/61/6*15
5	ACL-0020-EISH-EM75B	7.5	20	3.25	2.00%	0.7	95/61/6*15
6	ACL-0030-EISCL-EM47	11	30	5.13	2.00%	0.47	120/72/8.5*20
7	ACL-0040-EISCL-EM35	15	40	5.20	2.00%	0.35	120/72/8.5*20
8	ACL-0050-EISCL-EM28	18.5	50	6.91	2.00%	0.28	120/72/8.5*20

9	ACL-0060-EISCL-EM24	22	60	7.28	2.00%	0.24	120/72/8.5*20
10	ACL-0090-EISCL-EM16	37	90	7.55	2.00%	0.16	120/72/8.5*20
11	ACL-0120-EISCL-EM12	45	120	10.44	2.00%	0.12	120/92/8.5*20
12	ACL-0150-EISH-EM11B	55	150	14.8	2.00%	0.095	182/76/11*18
14	ACL-0200-EISH-E80UB	75	200	19.2	2.00%	0.07	182/96/11*18
15	ACL-0250-EISH-E65UB	110	250	22.1	2.00%	0.056	182/96/11*18
16	ACL-0290-EISH-E50UB	132	290	28.3	2.00%	0.048	214/100/11*18
17	ACL-0330-EISH-E50UB	160	330	28.3	2.00%	0.042	214/100/11*18
18	ACL-0390-EISH-E44UB	185	390	31.8	2.00%	0.036	243/112/12*20
19	ACL-0490-EISH-E35UB	220	490	43.6	2.00%	0.028	243/122/12*20
20	ACL-0530-EISH-E35UB	240	530	43.6	2.00%	0.026	243/122/12*20
21	ACL-0600-EISH-E25UB	280	600	52	2.00%	0.023	243/137/12*20
22	ACL-0660-EISH-E25UB	300	660	52	2.00%	0.021	243/137/12*20
23	ACL-0800-EISH-E25UB	380	800	68.5	2.00%	0.0175	260/175/12*20
24	ACL-1000-EISH-E14UB	450	1000	68.5	2.00%	0.014	260/175/12*20
25	ACL-1200-EISH-E11UB	550	1250	106	2.00%	0.0011	275/175/12*20
26	ACL-1600-EISH-E12UB	630	1600	110	2.00%	0.0087	275/175/12*20
690V voltage series							
1.	ACL-0015-EISA-E1M7	15	15	5.5	2.00%	1.7	95/80/6*15
2.	ACL-0025-EISA-E1M0	22	25	7	2.00%	1.05	120/72/8.5*20
3.	ACL-0035-EISA-EM73	37	35	9	2.00%	0.73	120/92/8.5*20
4.	ACL-0055-EISA-EM46	45	55	10.5	2.00%	0.465	120/92/8.5*20
5.	ACL-0070-EISA-EM36	55	70	16.5	2.00%	0.365	120/127/8.5*20
6.	ACL-0090-EISA-EM28	75	90	21	2.00%	0.285	182/88/11*18
7.	ACL-0125-EISA-EM20	90	125	23.5	2.00%	0.2	182/101/11*18
8.	ACL-0160-EISA-EM16	110/132	160	27	2.00%	0.16	182/111/11*18
9.	ACL-0200-EISA-EM12	160	200	30	2.00%	0.125	214/100/11*18
10.	ACL-0250-EISA-EM10	220	250	35	2.00%	0.105	214/125/11*18
11.	ACL-0300-EISA-E85U	250	300	41	2.00%	0.085	243/119/12*20
12.	ACL-0400-EISA-E65U	315/355	400	47	2.00%	0.065	243/134/12*20
13.	ACL-0500-EISA-E65U	450	500	53	2.00%	0.05	243/144/12*20
14.	ACL-0650-EISA-E40U	500/560	650	60	2.00%	0.04	225/175/15*25

15.	ACL-0800-EISA-E32U	630/750	800	80	2.00%	0.032	225/175/15*25
16.	ACL-0950-EISA-E27U	800	950	89	2.00%	0.027	225/175/15*25
17.	ACL-1200-EISA-E21U	900/1000	1200	100	2.00%	0.021	225/200/15*25

9-3. AC output choke

When the connection wire from the inverter to the motor is longer (over 20 meters), it is used to inhibit over-current caused due to the distributed capacitance. Meanwhile, it can also inhibit the radio interference of the inverter.

9-3-1.AC output choke

Item No.	Model	Power rating (kW)	Rated current (A)	N.W. (kg)	Voltage reduction (V)	Inductance (mH)	Installation dimension a/b/d(mm)
380V voltage series							
1	OCL-0005-EISC-E1M4	1.5	5	3.48	1.00%	1.4	91/65/6*11
2	OCL-0007-EISC-E1M0	2.2	7	2.54	1.00%	1	91/65/6*11
3	OCL-0010-ELSC-EM70	4.0	10	2.67	1.00%	0.7	91/65/6*11
4	OCL-0015-ELSC-EM47	5.5	15	3.45	1.00%	0.47	95/61/6*15
5	OCL-0020-ELSC-EM35	7.5	20	3.25	1.00%	0.35	95/616*15
6	OCL-0030-ELSC-EM23	11	30	5.5	1.00%	0.23	95/818.5*20
7	OCL-0040-ELSC-EM18	15	40	5.5	1.00%	0.18	95/81/8.5*20
8	OCL-0050-ELSC-EM14	18.5	50	5.6	1.00%	0.14	95/81/8.5*20
9	OCL-0060-ELSC-EM12	22	60	5.8	1.00%	0.12	120/72/8.5*20
10	OCL-0080-ELSC-E87U	30	80	6.0	1.00%	0.087	120/72/8.5*20
11	OCL-0090-ELSC-E78U	37	90	6.0	1.00%	0.078	120/72/8.5*20
12	OCL-0120-ELSC-FbU	45	120	9.6	1.00%	0.058	120/92/8.5*20
13	OCL-0150-EISH-E47U	55	150	15	1.00%	0.047	182/87/11*18
14	OCL-0200-EISH-E35U	75	200	17.3	1.00%	0.035	182/97/11*18
15	OCL-0250-EISH-E28U	110	250	17.8	1.00%	0.028	182/97/11*18
16	OCL-0290-EISH-E24U	132	290	24.7	1.00%	0.024	214/101/11*18
17	OCL-0330-EISH-E21U	160	330	26	1.00%	0.021	214/106/11*18
18	OCL-0390-EISH-E18U	185	390	26.5	1.00%	0.018	214/106/11*18
19	OCL-0490-EISH-E14U	220	490	36.6	1.00%	0.014	243/113/12*20
20	OCL-0530-EISH-E13U	240	530	36.6	1.00%	0.013	243/113/12*20
21	OCL-0600-EISH-E12U	280	600	43.5	1.00%	0.012	243/128/12*20
22	OCL-0660-EISH-E4F0	300	660	44	1.00%	0.011	243/128/12*20

23	OCL-0800-EISH-FbF0	380	800	60.8	1.00%	0.0087	260/175/12*20
24	OCL-1000-EISH-E4F0	450	1000	61.5	1.00%	0.007	260/175/12*20
25	OCL-1200-EISH-E4F0	550	1200	89	1.00%	0.0058	275/175/12*20
26	OCL-1600-EISH-E3F0	630	1600	92	1.00%	0.0043	275/175/12*20
690V voltage series							
1.	OCL-0015-EISA-EM85	15	15	-	1.00%	0.85	120/72/8.5*20
2.	OCL-0025-EISA-EM51	22	25	-	1.00%	0.51	120/72/8.5*20
3.	OCL-0035-EISA-EM36	37	35	-	1.00%	0.36	120/85/8.5*20
4.	OCL-0055-EISA-EM23	45	55	-	1.00%	0.23	20/107/8.5*20
5.	OCL-0070-EISA-EM18	55	70	-	1.00%	0.182	182/79/11*18
6.	OCL-0090-EISA-EM14	75	90	-	1.00%	0.142	182/89/11*18
7.	OCL-0125-EISA-EM10	90	125	-	1.00%	0.1	182/106/11*18
8.	OCL-0160-EISA-E80U	110/132	160	-	1.00%	0.08	214/100/11*18
9.	OCL-0200-EISA-E64U	160	200	-	1.00%	0.064	214/105/11*18
10.	OCL-0250-EISA-E50U	220	250	-	1.00%	0.05	214/125/11*18
11.	OCL-0300-EISA-E42U	250	300	-	1.00%	0.042	243/129/12*20
12.	OCL-0400-EISA-E32U	315/355	400	-	1.00%	0.032	243/144/12*20
13.	OCL-0500-EISA-E25U	450	500	-	1.00%	0.025	243/149/12*20
14.	OCL-0650-EISA-E20U	500/560	650	-	1.00%	0.02	225/150/15*25
15.	OCL-0800-EISA-E16U	630/750	800	-	1.00%	0.016	225/175/15*25
16.	OCL-0950-EISA-E13U	800	950	-	1.00%	0.013	225/175/15*25
17.	OCL-1200-EISA-E10U	900/1000	1200	-	1.00%	0.01	225/200/15*25

9-4. DC choke

Item No.	Model	Power rating (kW)	Rated current (A)	N.W.(kg)	Inductance(mH)	Installation dimension a/b/d(mm)
380V voltage series						
1	DCL-0003-EIDC-E28M	0.4	3	1.5	28	63/47/5.4*9
2	DCL-0003-EIDC-E28M	0.8	3	1.5	28	63/47/5.4*9
3	DCL-0006-EIDC-E11M	1.5	6	2.3	11	63/60/5.4*9
4	DCL-0006-EIDC-E11M	2.2	6	2.3	11	63/60/5.4*9
5	DCL-0012-EIDC-E6M3	4.0	12	3.2	6.3	80/70/6*11
6	DCL-0023-EIDH-E3M6	5.5	23	3.8	3.6	87/70/6*11

7	DCL-0023-EIDH-E3M6	7.5	23	3.8	3.6	87/70/6*11
8	DCL-0033-EIDH-E2M0	11	33	4.3	2	87/70/6*11
9	DCL-0033-EIDH-E2M0	15	33	4.3	2	87/70/6*11
10	DCL-0040-EIDH-E1M3	18.5	40	4.3	1.3	87/70/6*11
11	DCL-0050-EIDH-E1M1	22	50	5.5	1.08	95/85/8.4*13
12	DCL-0065-EIDH-EM80	30	65	7.2	0.8	111/85/8.4*13
13	DCL-0078-EIDH-EM70	37	78	7.5	0.7	111/85/8.4*13
14	DCL-0095-EIDH-EM54	45	95	7.8	0.54	111/85/8.4*13
15	DCL-0115-EIDH-EM45	55	115	9.2	0.45	125/90/9*18
16	DCL-0160-UIDH-EM36	75	160	10	0.36	100/98/9*18
17	DCL-0180-UIDH-EM33	93	180	20	0.33	100/98/9*18
18	DCL-0250-UIDH-EM26	110	250	23	0.26	176/115/11*18
19	DCL-0250-UIDH-EM26	132	250	23	0.26	176/115/11*18
20	DCL-0340-UIDH-EM17	160	340	23	0.17	176/115/11*18
21	DCL-0460-UIDH-EM09	185	460	28	0.09	191/115/11*18
22	DCL-0460-UIDH-EM09	220	460	28	0.09	191/115/11*18
23	DCL-0650-UIDH-E72U	300	650	33	0.072	206/125/11*18
690V voltage series						
1.	DCL-0095-UIDA-E1M0	55	95	-	1.0	100/127/9*18
2.	DCL-0120-UIDA-EM85	75	120	-	0.85	100/142/9*18
3.	DCL-0165-UIDA-EM65	90	165	-	0.65	176/126/11*18
4.	DCL-0210-UIDA-EM47	132	210	-	0.47	176/131/11*18
5.	DCL-0264-UIDA-EM38	160	264	-	0.38	176/151/11*18

9-5. Input filter

Item No.	Model	Voltage (V)	Power rating (kW)	Rated current (A)	N.W. (kg)	dimension L/W/H (mm)	Installation dimension a/b/d(mm)
1	YX82G2-5A-S	380	0.75~1.5	5	0.54	100/105/40	50/95/Φ4.5*6.5
2	YX82G2-10A-S	380	2.2~4	10	0.55	100/105/40	50/95/Φ4.5*6.5
3	YX82G5D-20A-S	380	5.5~7.5	16	1.6	185/105/60	167.8/85/Φ6.5*9.2
4	YX82G5D-36A-S	380	11~15	36	1.8	185/105/60	167.8/85/Φ6.5*9.2
5	YX82G5D-50A-S	380	18.5~22	45	1.6	185/105/60	167.8/85/Φ6.5*9.2
6	YX82G6D-65A-S	380	30	65	-	310/170/107	280/142.5/Φ8.5*14

7	YX82G6D-80A-S	380	37	80	6.3	310/170/107	280/142.5/Φ8.5*14
8	YX82G6D-100A-S	380	45	100	6.4	310/170/107	280/142.5/Φ8.5*14
9	YX82G6D-120A-S	380	55	120	7.4	310/170/107	280/142.5/Φ8.5*14
10	YX82G7D-150A-S	380	75	150	8.9	352/185/112	325/151/Φ8.5*14
11	YX82G7D-200A-S	380	93	200	-	352/185/112	325/151/Φ8.5*14
12	YX82G8-400A-B	380	200	300	12	380/220/155	228/195/Φ12

9-6. Output filter

Item No.	Model	Voltage (V)	Power rating (kW)	Rated current (A)	N.W. (kg)	dimension L/W/H(mm)	Installation dimension a/b/d(mm)
1	YX82G2-5A-SL	380	0.75~1.5	5	0.5	100/105/40	50/95/Φ4.5*6.5
2	YX82G2-10A-SL	380	2.2~4	10	0.55	185/105/60	50/95/Φ4.5*6.5
3	YX82G5D-20A-SL	380	5.5~7.5	20	1.6	185/105/60	167.8/85/Φ6.5*9.2
4	YX82G5D-36A-SL	380	11~15	36	1.8	185/105/60	167.8/85/Φ6.5*9.2
5	YX82G5D-50A-SL	380	18.5~22	50	1.7	185/105/60	167.8/85/Φ6.5*9.2
6	YX82G6D-65A-SL	380	30	65	6.2	310/170/107	280/142.5/Φ8.5*14
7	YX82G6D-80A-SL	380	37	80	6.2	310/170/107	280/142.5/Φ8.5*14
8	YX82G6D-100A-SL	380	45	100	6.5	310/170/107	280/142.5/Φ8.5*14
9	YX82G6D-120A-SL	380	55	150	6.5	310/170/107	280/142.5/Φ8.5*14
10	YX82G7D-150A-SL	380	75	200	9.2	352/185/112	325/151/Φ8.5*14
11	YX82G7D-200A-SL	380	93	250	-	352/185/112	325/151/Φ8.5*14
12	YX82G8D-300A-BL	380	110	300	11.5	380/220/155	228/195/Φ12
13	YX82G8D-400A-BL	380	200	400	11.6	380/220/155	228/195/Φ12
14	YX82G9D-630A-BL	380	280~315	630	18.5	448/255/162	290/230/Φ12

9-7. Brake unit and brake resistor

15-22kW PI500 frequency inverter is with built-in brake unit, maximum brake torque is 50%. User should select the brake resistor according to below chart; 30kW and 30kW above unit should use additional brake unit, brake unit and brake resistor are listed below.

1.380V 18kW~22kW below models (built-in) braking resistor selection as below:

Frequency inverter voltage	Capability (kW)	Resistance of braking resistor(Ω)	Capability of braking resistor(kW)
380V	7.5 kW	75Ω	780W
	11 kW	50Ω	1000W
	15 kW	40Ω	1500W
	18.5 kW	32Ω	1800W
	22 kW	25Ω	2100W

2.380V 30kW and above models external braking unit and braking resistor selection:

Inverter power(kW)	Braking unit		Braking resistor(braking torque 150%)	
	model	Quantity(pcs)	model	Quantity(pcs)
30	PB6024	1	20Ω/6000W	1
37		1	16Ω/9600W	1
45		1	13.6Ω/9600W	1
55		1	10Ω/12000W	1
75		1	6.8Ω/12000W	1
93	PB6034	1	6.8Ω/12000W	1
110		1	6.8Ω/12000W	1
132	PB6034	2	6.8Ω/12000W	2
160		2	6.8Ω/12000W	2
187	PB6034	3	6.8Ω/12000W	3
200		3	6.8Ω/12000W	3

9-8. Main Circuit Breaker (MCCB), Contactor, Wire**9-8-1. Molded case circuit breaker (MCCB) or earth leakage circuit breaker (ELCB)**

MCCB or ELCB as the power switch of the inverter also plays a protective role to the power supply. Note: do not use MCCB or ELCB to control start/stop of the inverter. The capacity of the circuit breaker is 1.5~2 times the rated current of the inverter.

9-8-2. Contactor

It's used to cut off power supply to prevent the failure to be expanded when the protection function of the system is activated. The contactor can not be used to control the stop/start of the motor.

Model	breaker(A)	Input cable/output cable (copper cable)mm ²	Contactor rated working current A (voltage 380V or 220V)
015G3	63A	6	50
018G3	100A	10	63
022G3	100A	10	80
030G3	125A	16	95
037G3	160A	25	120
045G3	200A	35	135
055G3	250A	50	170
075G3	315A	70	230
093G3	400A	70	280
110G3	400A	95	315
132G3	400A	95	380
160G3	630A	150	450
187G3	630A	95x2	500
200G3	630A	95x2	580
220G3	800A	150x2	630
250G3	800A	150x2	700
280G3	1000A	150x3	780
315G3	1200A	150x3	900
355G3	1280A	150x3	960
400G3	1600A	150x4	1035
450G3	1600A	185x3	1230
500G3	2000A	185x3	1290
560G3	2000A	240x3	1425
630G3	2000A	240x3	1650

9-8-3. Cable

1. Power cables

The dimension of input power cable and motor cable should meet the local provision:

Input power cable and motor cable should bear the related load current.

The maximum rated temperature margin conditions of the motor cable should not be sustained below 70 degrees.

Conductivity of the PE conductor and phase conductor capacity are the same (same cross-sectional area),

About EMC requirements, see "EMC Guidance Content"

To meet the CE EMC requirements, a symmetrical shielded motor cable must be used (see figure below). For input cables can use four-core cable, but still recommended to use shielded symmetrical cable. Compared to a four-core cable, shielded symmetrical cables can not only reduce the loss and cost of the current flowing through the motor cable, but also can reduce the electromagnetic radiation.

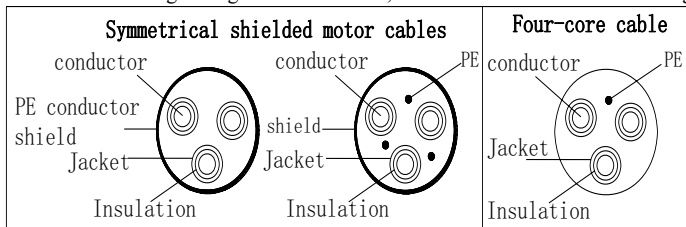

Note: If conductivity of the cable shield can not meet the requirements, you must use a separate PE conductor.

To play a protective role of conductor, when the shield wire and phase conductors using the same material, the cross-sectional area of the shield wire and phase conductors cross-sectional area must be the same, aims to reduce grounding resistance, impedance continuity better.

To effectively suppress RFI transmission and conduction, the shield conductivity must be at least 1/10 of the phase conductor conductivity. For copper or aluminum shield, this requirement is very easy to meet. Minimum requirements for the drive motor cable as shown below. Cable comprising a layer of copper spiral. Shield tight as possible, that the more tightly the more we can effectively suppress radiated electromagnetic interference.

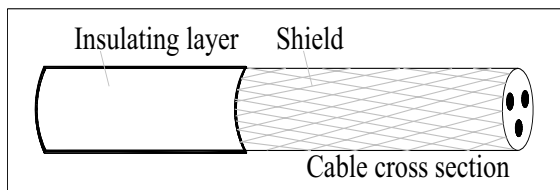

2. Control Cable

All analog control cables and cables for the frequency input must be shielded. Analog signal cable double-shielded twisted pair cable as shown in Figure 1. Each signal uses one pair individually shielded twisted pair cable pair. Do not use the different analog signal with a ground wire.

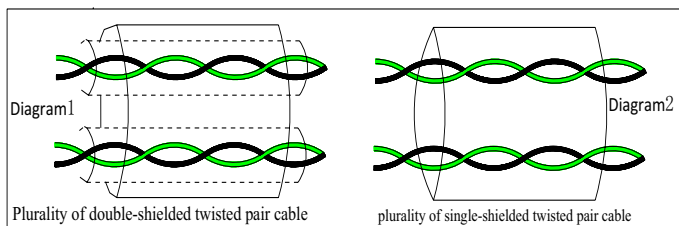

For low-voltage digital signals, double-shielded cable is the best choice, but can also be a single-shielded or unshielded twisted pair, as shown in Figure 2, however, the frequency of the signal, it can only use a shielded cable.

Relay cable need to use cables with metal braid shield.

Need to use a network cable to connect the keyboard, for electromagnetic environment is more complex place, it is recommended to use shielded cable.

Note: analog and digital signals using different cables routed separately.

Chapter 10 Warranty

The product quality shall comply with the following provisions:

1. Warranty terms

1-1. The product from the user the date of purchase, the warranty period of 12 months (limited to domestic market).

1-2. Export products and non-standard products warranty period is 12 months or according to the agreement of warranty execution.

1-3. The product from the user the purchase date, guarantee to return, replacement, repair service, within one month after the date of shipment.

1-4. The product from the user the date of purchase, replacement, repair within three months after the date of shipment.

1-5. The product from the user the purchase date, enjoy lifelong compensable service.

2. Exceptions clause

If belongs to the quality problems caused by following reasons products, not within the warranty.

2-1. The user is not in accordance with the "products manual" is used method of operation caused the failure.

2-2. Users without permission to repair or alteration caused by product failure.

2-3. Users beyond the standard specifications require the use of the inverter caused by product failure.

2-4. Users to buy and then fell loss or damage caused by improper handling.

2-5. Because the user use environment device caused by aging lead to product failure.

2-6. Due to the fault cause of earthquake, fire, lightning, wind or water disaster, abnormal voltage irresistible natural disasters.

2-7. Damaged during shipping (Note: the transport mode specified by the customer, the company to assist to handle cargo transfer procedures).

3. The following conditions, manufacturers have the right not to be warranty

3-1. No product nameplate or product nameplate blurred beyond recognition.

3-2. Not according to the purchase contract agreement to pay the money.

3-3. For installation, wiring, operation, maintenance and other users can not describe the objective reality to the company's technical service center.

4. In return, replacement, repair service, shall be returned the company, confirmed the attribution of responsibility, can be returned or repair

Appendix I RS485 Communication protocol

I-1 Communication protocol

I-1-1 Communication content

This serial communication protocol defines the transmission information and use format in the series communication Including: master polling(or broadcast) format; master encoding method, and contents including: function code of action, transferring data and error checking. The response of slave also adopts the same structure, and contents including: action confirmation, returning the data and error checking etc. If slave takes place the error while it is receiving information or cannot finish the action demanded by master, it will send one fault signal to master as a response.

Application Method

The inverter will be connected into a “Single-master Multi-slave” PC/PLC control network with RS485 bus.

Bus structure

(1)Transmission mode

Asynchronous series and half-duplex transmission mode. For master and slave, only one of them can send the data and the other only receives the data at the same time. In the series asynchronous communication, the data is sent out frame by frame in the form of message

(2)Topological structure

Single-master and multi-slave system. The setting range of slave address is 0 to 247, and 0 refers to broadcast communication address. The address of slave for network must be exclusive.

Diagram I-3 is the single inverter and PC set up MODBUS field wiring diagram. Because computers are generally not with RS485 interface, the computer must be built-in RS232 interface or USB interface through the converter to convert to RS485. Connect the T + of converter with 485 + terminal of the inverter, Connect the T - of converter with 485- terminal of inverter. We recommended to use a shielded twisted pair. When adopting the RS232-485 converter,RS232 interface connected with RS232-RS485 RS232 interface, the cable should be as short as possible,15meters at the longest, we recommend to plug the RS232-RS485 with computer in pair directly. Similarly, when using the USB-RS485 converter, cable should be as short as possible.

When the line is connected, connect the right port of the host computer on the computer to (RS232-RS485 converter port, such as COM1), and set the basic parameters and the baud rate and data bit parity and so on consistent with the inverter.

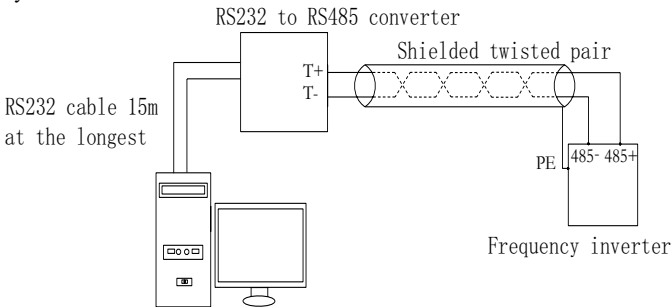

Diagram I-3

Multiple Applications

In reality, multi-machine applications, there are two connections

The first inverter and the last inverter short the terminal resistor on the control board to be active.

As shown in Figure I-4

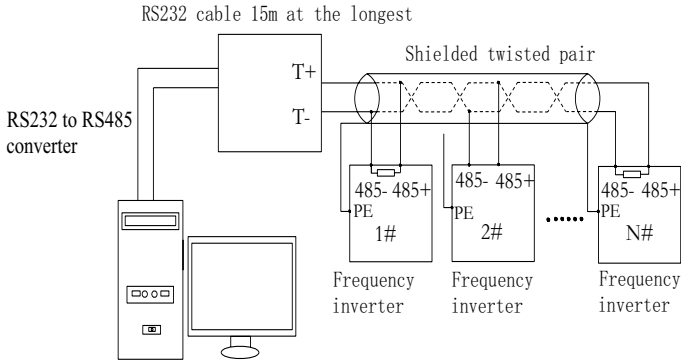

Diagram I-4

The two longest distance inverter from the device shall short the terminal resistor on the control board to be active. As shown in Figure I-5:

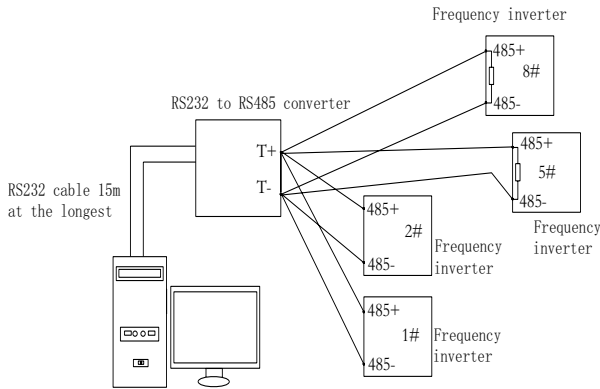

Diagram I-5

Multi-machine connection should try to use a shielded cable. The basic parameters such as baud rate and data bit of all of the devices on RS485 line must be the same, address must be different.

NOTE: The terminal resistor of 485 decides valid or invalid through the control board (No. 485) jumper

I-1-2 Protocol description

PI500 series inverter communication protocol is a asynchronous serial master-slave communication protocol, in the network, only one equipment(master) can build a protocol (known as "Inquiry/Command"). Other equipment(slave) only can response the "Inquiry/Command" of master by providing data or perform the corresponding action according to the "Inquiry/Command" of master. Here, the master refers to a Personnel Computer(PC), an industrial control device or a programmable logic controller (PLC), etc. and the slave refers to PI500 inverter. Master can communicate with individual slave, also send broadcasting information to all the lower slaves. For the single "Inquiry/Command" of master, slave will return a signal(that is a response) to master; for the broadcasting information sent by master, slave does not need to feedback a response to master.

Communication data structure PI500 series inverter's Modbus protocol communication data format is as follows: in RTU mode, messages are sent at a silent interval of at least 3.5 characters. There are diverse character intervals under network baud rate,

which is easiest implemented. The first field transmitted is the device address.

Appendix I

The allowable characters for transmitting are hexadecimal 0 ... 9, A ... F. The networked devices continuously monitor network bus, including during the silent intervals. When the first field (the address field) is received, each device decodes it to find out if it is sent to their own. Following the last transmitted character, a silent interval of at least 3.5 characters marks the end of the message. A new message can begin after this silent interval.

The entire message frame must be transmitted as a continuous stream. If a silent interval of more than 1.5 characters occurs before completion of the frame, the receiving device will flush the incomplete message and assumes that the next byte will be the address field of a new message. Similarly, if a new message begins earlier than the interval of 3.5 characters following a previous message, the receiving device will consider it as a continuation of the previous message. This will result in an error, because the value in the final CRC field is not right.

RTUframe format :

Frame header START	Time interval of 3.5characters
Slave address ADR	Communication address: 1 to 247
Command code CMD	03: read slave parameters; 06: write slave parameters
Data content DATA(N-1)	Data content: address of function code parameter, numbers of function code parameter, value of function code parameter, etc.
Data content DATA(N-2)	
.....	
Data content DATA0	
CRC CHK high-order	Detection Value: CRC value.
CRC CHK low-order	
END	Time interval of 3.5characters

CMD (Command) and DATA (data word description)

Command code: 03H, reads N words (max.12 words), for example: for the inverter with slave address 01, its start address F0.02 continuously reads two values.

Master command information

ADR	01H
CMD	03H
Start address high-order	F0H
Start address low-order	02H
Number of registers high-order	00H
Number of registers low-order	02H
CRC CHK low-order	CRC CHK values are to be calculated
CRC CHK high-order	

Slave responding information

When F9.05 is set to 0:

ADR	01H
CMD	03H
Byte number high-order	00H
Byte number low-order	04H
Data F002H high-order	00H
Data F002H low-order	01H
Data F003H high-order	00H
Data F003H low-order	01H
CRC CHK low-order	CRC CHK values are to be calculated
CRC CHK high-order	

When F9.05is set to 1:

ADR	01H
CMD	03H
Byte number	04H

Data F002H high-order	00H
Data F002H low-order	01H
Data F003H high-order	00H
Data F003H low-order	01H
CRC CHK low-order	CRC CHK values are to be calculated
CRC CHK high-order	

Command Code: 06H, write a word. For example: Write 5000(1388H) into the address F013H of the inverter with slave address 02H.

Master command information

ADR	02H
CMD	06H
Data address high-order	F0H
Data address low-order	13H
Data content high-order	13H
Data content low-order	88H
CRC CHK low-order	CRC CHK values are to be calculated
CRC CHK high-order	

Slave responding information

ADR	02H
CMD	06H
Data address high-order	F0H
Data address low-order	13H
Data content high-order	13H
Data content low-order	88H
CRC CHK low-order	CRC CHK values are to be calculated
CRC CHK high-order	

I-2 Check mode:

Check mode - CRC mode: CRC (Cyclical Redundancy Check) adopts RTU frame format, the message includes an error-checking field that is based on CRC method. The CRC field checks the whole content of message. The CRC field has two bytes containing a 16-bit binary value. The CRC value calculated by the transmitting device will be added into to the message. The receiving device recalculates the value of the received CRC, and compares the calculated value to the Actual value of the received CRC field, if the two values are not equal, then there is an error in the transmission.

The CRC firstly stores 0xFFFF and then calls for a process to deal with the successive eight-bit bytes in message and the value of the current register. Only the 8-bit data in each character is valid to the CRC, the start bit and stop bit, and parity bit are invalid.

During generation of the CRC, each eight-bit character is exclusive OR(XOR) with the register contents separately, the result moves to the direction of least significant bit(LSB), and the most significant bit(MSB) is filled with 0. LSB will be picked up for detection, if LSB is 1, the register will be XOR with the preset value separately, if LSB is 0, then no XOR takes place. The whole process is repeated eight times. After the last bit (eighth) is completed, the next eight-bit byte will be XOR with the register's current value separately again. The final value of the register is the CRC value that all the bytes of the message have been applied.

When the CRC is appended to the message, the low byte is appended firstly, followed by the high byte. CRC simple functions is as follows:

```

unsigned int crc_chk_value(unsigned char *data_value,unsigned char length)
{
    unsigned int crc_value=0xFFFF;
    int i;

```

```

while(length-->0)
{
    crc_value^=*data_value++;
    for(i=0;i<8;i++)
    {
        if(crc_value&0x0001)
        {
            crc_value=(crc_value>>1)^0xa001;
        }
        else
        {
            crc_value=crc_value>>1;
        }
    }
}
return(crc_value);
}
    
```

I-3 Definition of communication parameter address

The section is about communication contents, it's used to control the operation, status and related parameter settings of the inverter. Read and write function-code parameters (Some functional code is not changed, only for the manufacturer use or monitoring): the rules of labeling function code parameters address:

The group number and label number of function code is used to indicate the parameter address:

High byte: F0 to FB (F group), A0 to AF (E group), B0 to BF(B group),C0 to C7(Y group),70 to 7F (d group) low byte: 00 to FF

For example: address F3.12 indicates F30C; Note: L0 group parameters: neither read nor change; d group parameters: only read, not change.

Some parameters can not be changed during operation, but some parameters can not be changed regardless of the inverter is in what state. When changing the function code parameters, please pay attention to the scope, units, and relative instructions on the parameter.

Besides, due to EEPROM is frequently stored, it will reduce the life of EEPROM, therefore under the communication mode some function code do not need to be stored and you just change the RAM value.

If F group parameters need to achieve the function, as long as change high order F of the function code address to 0. If E group parameters need to achieve the function, as long as change high order F of the function code address to 4. The corresponding function code addresses are indicated below: high byte: 00 to 0F(F group), 40 to 4F (E group), 50 to 5F(B group),60 to 67(Y group)low byte:00 to FF

For example:

Function code F3.12 can not be stored into EEPROM, address indicates as 030C; function code E3.05 can not be stored into EEPROM, address indicates as 4305; the address indicates that only writing RAM can be done and reading can not be done, when reading, it is invalid address. For all parameters, you can also use the command code 07H to achieve the function.

Stop/Run parameters section:

Parameter address	Parameter description	Parameter address	Parameter description
-------------------	-----------------------	-------------------	-----------------------

1000	*Communication set value(-10000 to10000)(Decimal)	1011	PID feedback
1001	Running frequency	1012	PLC step
1002	Bus voltage	1013	High-speed pulse input frequency, unit: 0.01kHz
1003	Output voltage	1014	Feedback speed, unit:0.1Hz
1004	Output current	1015	Remaining run time
1005	Output power	1016	AI1 voltage before correction
1006	Output torque	1017	AI2 voltage before correction
1007	Operating speed	1018	Reserve
1008	DI input flag	1019	Linear speed
1009	DO output flag	101A	Current power-on time
100A	AI1 voltage	101B	Current run time
100B	AI2 voltage	101C	High-speed pulse input frequency, unit: 1Hz
100C	AI3 voltage	101D	Communication set value
100D	Count value input	101E	Actual feedback speed
100E	Length value input	101F	Master frequency display
100F	Load speed	1020	Auxiliary frequency display
1010	PID setting		

Note:

There is two ways to modify the settings frequencies through communication mode:

The first: Set F0.03 (main frequency source setting) as 0/1 (keyboard set frequency), and then modify the settings frequency by modifying F0.01 (keyboard set frequency). Communication mapping address of F0.01 is 0xF001 (Only need to change the RAM communication mapping address to 0x0001).

The second :Set F0.03 (main frequency source setting) as 9 (Remote communication set), and then modify the settings frequency by modifying (Communication settings). , mailing address of this parameter is 0x1000.the communication set value is the percentage of the relative value, 10000 corresponds to 100.00%, -10000 corresponds to -100.00%. For frequency dimension data, it is the percentage of the maximum frequency (F0.19); for torque dimension data, the percentage is F5.08 (torque upper limit digital setting).

Control command is input to the inverter: (write only)

Command word address	Command function
2000	0001: Forward run
	0002: Reverse run
	0003: Forward Jog
	0004: Reverse Jog
	0005: Free stop
	0006: Deceleration and stop
	0007: Fault reset

Inverter read status: (read-only)

Status word address	Status word function
3000	0001: Forward run
	0002: Reverse run
	0003: Stop

Parameter lock password verification: (If the return code is 8888H, it indicates that password verification is passed)

Password address	Enter password
------------------	----------------

Appendix I

C000	*****
------	-------

Digital output terminal control: (write only)

Command address	Command content
2001	BIT0: SPA output control BIT1: RELAY2 output control BIT2 RELAY1 output control BIT3: Manufacturer reserves the undefined BIT4: SPB switching quantity output control

Analog output DA1 control: (write only)

Command address	Command content
2002	0 to 7FFF indicates 0% to 100%

Analog output DA2 control: (write only)

Command address	Command content
2003	0 to 7FFF indicates 0% to 100%

SPB high-speed pulse output control: (write only)

Command address	Command content
2004	0 to 7FFF indicates 0% to 100%

Inverter fault description:

Inverter fault address:	Inverter fault information:
8000	0000: No fault 0001: Inverter unit protection 0002: Acceleration overcurrent 0003: Deceleration overcurrent 0004: Constant speed overcurrent 0005: Acceleration overvoltage 0006: Deceleration overvoltage 0007: Constant speed overvoltage 0008: Control power failure 0009: Undervoltage fault 000A: Inverter overload 000B: Motor Overload 000C: Input phase loss 000D: Output phase loss 000E: Module overheating 000F: External fault 0010: Communication abnormal 0011: Contactor abnormal 0012: Current detection fault 0013: Motor parameter auto tuning fault 0014: Encoder/PG card abnormal 0015: Parameter read and write abnormal 0016: Inverter hardware fault 0017: Motor short to ground fault 0018: Reserved 0019: Reserved 001A: Running time arrival 001B: Custom fault 1 001C: Custom fault 2 001D: Power-on time arrival 001E: Load drop

	001F: PID feedback loss when running 0028: Fast current limiting timeout 0029: Switch motor when running fault 002A: Too large speed deviation 002B: Motor overspeed 002D: Motor overtemperature 005A: Encoder lines setting error 005B: Missed encoder 005C: Initial position error 005E: Speed feedback error
--	--

Data on communication failure information description (fault code):

Communication fault address	Fault function description
8001	0000: No fault 0001: Password error 0002: Command code error 0003: CRC check error 0004: Invalid address 0005: Invalid parameters 0006: Invalid parameter changes 0007: System locked 0008: EEPROM in operation

F9Group - Communication parameter description

F9.00	Baud rate	Default	6005
	Setting range	Units digit: MODUBUS baud rate 0: 300BPS 1: 600BPS 2: 1200BPS 3: 2400BPS 4: 4800BPS 5: 9600BPS 6: 19200BPS 7: 38400BPS 8: 57600BPS 9: 115200BPS	

This parameter is used to set the data transfer rate between the host computer and the inverter. Note: the baud rate must be set to the same for the host computer and the inverter, otherwise communication can not be achieved. The larger baud rate, the faster communication speed.

F9.01	Data format	Default	0
	Setting range	0: no parity: data format <8, N, 2> 1: even parity: data format <8, E, 1> 2: odd parity: data format <8, O, 1> 3: no parity: data format <8-N-1>	

Note: the set data for the host computer and the inverter must be the same.

F9.02	This unit address	Default	1
	Setting range	1 to 247, 0 for broadcast address	

When the address of this unit is set 0, that is broadcast address, the broadcasting function for the host computer can be achieved.

The address of this unit has uniqueness (in addition to the broadcast address), which is the basis of peer-to-peer communication for the host computer and the inverter.

Appendix II Description on proportion linkage function

II-1.Function

Proportional linkage master:

Communication address of master =248

Proportional linkage slave:

Communication address of slave =1 to 247

If you want to use proportion linkage function, master parameters setting as follows:

F9.00	Baud rate	Same as slave
F9.01	Data format	Same as slave
F9.02	This unit address	248

Slave parameters setting as follows

F9.00	Baud rate	Same as master
F9.01	Data format	Same as master
F9.02	This unit address	1 to 247
FC.01	Proportional linkage coefficient	0.00: invalid; 0.01 to 10.00

Slave output frequency = Master setting frequency * Proportional linkage coefficient + UP/DOWN Changes.

II-2.Examples of proportion linkage function:

Functions provided by proportional linkage system:

1. Master adjusts system speed via AI1 and controls FRW/REV run by using terminals;
2. Slave runs following mater, the proportional linkage coefficient is 0.90; (when it is powered on, master displays 50Hz, and slave displays 45Hz)
3. Slave receives the running speed command from master and save it into F0.01.
4. The actual setting frequency of slave can be fine-tuned by the operation of rising and falling of keypad or terminals.
5. The actual setting frequency of slave can be fine-tuned by the analog AI2 too.
6. The actual setting frequency of slave = F0.01 + slave AI2 analog trimming + UP/DOWN Changes.

Proportional linkage master setting:

F0.11	Command source selection	1: Terminal block control
F0.03	Frequency source master setting	2: Analog AI1 setting
F1.00	DI1 input terminal function selection	1. FRW run command
F1.01	DI2 input terminal function selection	2. REV run command
F9.01	Baud rate	6005
F9.02	Communication address of this unit	Proportional linkage master 248
F9.03	Communication format	0

Proportional linkage slave setting:

F0.03	Frequency source master setting	0: keyboard set frequency
F0.04	Frequency source auxiliary setting	3: Analog AI2 setting
F0.07	Frequency overlay selection	01: master + auxiliary
F1.00	DI1 input terminal function selection	6. UP command
F1.01	DI2 input terminal function selection	7. DOWN command
F1.02	DI3 input terminal function selection	8: Free stop
F9.00	Baud rate	Same as master
F9.02	Communication address of this unit	1 to 247
F9.03	Communication format	Same as master
FC.01	Proportional linkage coefficient	0.90

System wiring diagram:

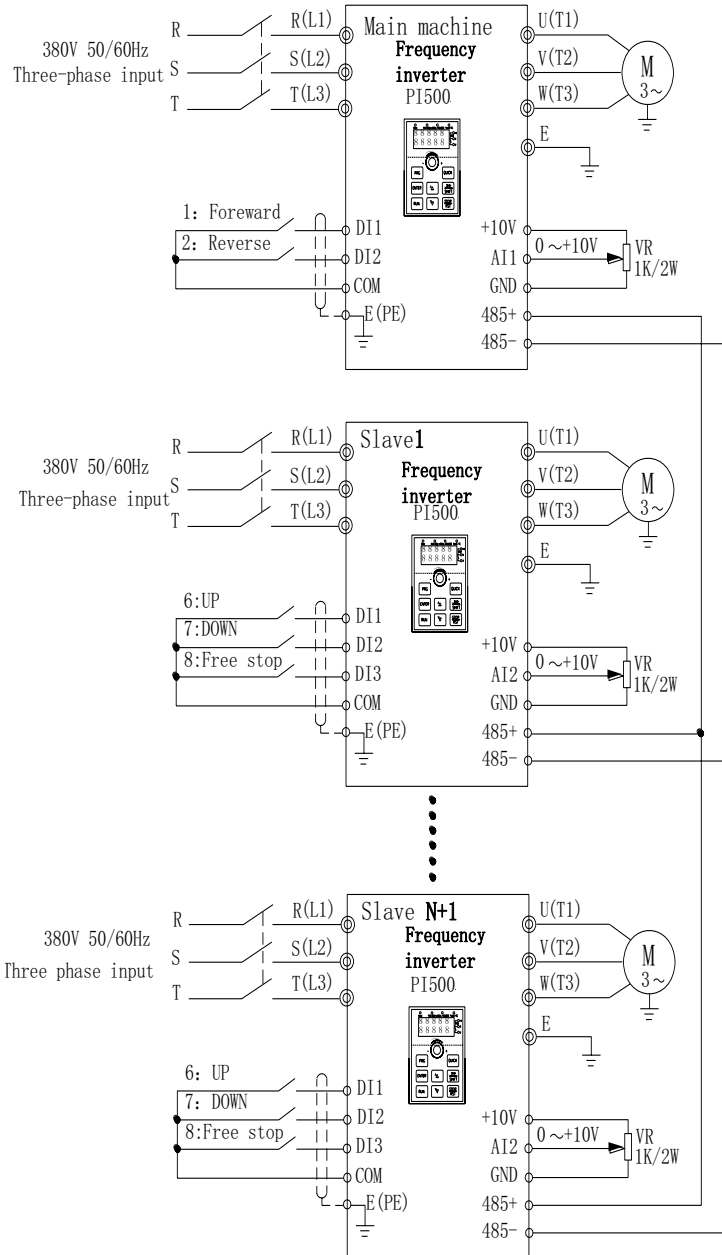

Diagram II-1: System wiring diagram

Appendix III How to use universal encoder expansion card

III-1 Overview

PI500 is equipped with a variety of universal encoder expansion card (PG card), as an optional accessory, it is necessary part for the inverter closed-loop vector control, please select PG card according to the form of encoder output, the specific models are as follows:

Options	Description	Others
PI500_PG1	ABZ incremental encoder: Differential input PG card, without frequency dividing output. OC input PG card, without frequency dividing output.5V, 12V, 24V voltage is optional, please provide voltage and pulse input mode information when ordering.	Terminal wiring
PI500_PG3	UVW incremental encoder. UVW Differential input PG card, without frequency dividing output.5V voltage	Terminal wiring
PI500_PG4	Rotational transformer PG card	Terminal wiring
PI500_PG5	ABZ incremental encoder. OC input PG card, with 1:1 frequency dividing output. 5V, 12V, 24V voltage is optional, please provide voltage and pulse input mode information when ordering.	Terminal wiring

III-2 Description of mechanical installation and control terminals function

The expansion card specifications and terminal signals for each encoder are defined as follows:
Table 1 Definitions of specifications and terminal signals

Differential PG card(PI500_PG1)					
PI500_PG1 specifications					
User interface			Terminal block		
Spacing			3.5mm		
Screw			Slotted		
Swappable			NO		
Wire gauge			16-26AWG(1.318~0.1281mm ²)		
Maximum frequency			500kHz		
Input differential signal amplitude			≤7V		
PI500_PG1 terminal signals					
No.	Label no.	Description	No.	Label no.	Description
1	A+	Encoder output A signal positive	6	Z-	Encoder output Z signal negative
2	A-	Encoder output A signal negative	7	5V	Provide 5V/100mA power
3	B+	Encoder output B signal positive	8	GND	Power ground
4	B-	Encoder output B signal negative	9	PE	Shielding terminal
5	Z+	Encoder output Z signal positive			
UVWdifferential PG card					
PI500_PG3 specifications					
User interface			Terminal block		
Swappable			NO		
Wire gauge			>22AWG(0.3247mm ²)		

Maximum frequency		500kHz			
Input differential signal amplitude		≤7V			
PI500 PG3 terminal description					
Item No.	Label no.	Description	Item No.	Label no.	Description
1	A+	Encoder output A signal positive	9	V+	Encoder output V signal positive
2	A-	Encoder output A signal negative	10	V-	Encoder output V signal negative
3	B+	Encoder output B signal positive	11	W+	Encoder output W signal positive
4	B-	Encoder output B signal negative	12	W-	Encoder output W signal negative
5	Z+	Encoder output Z signal positive	13	+5V	Output 15V/100mA power
6	Z-	Encoder output Z signal negative	14	GND	Power ground
7	U+	Encoder output U signal positive	15	-	
8	U-	Encoder output U signal negative			
Rotational transformer PG card(PI500 PG4)					
PI500 PG4 specifications					
User interface		Terminal block			
Swappable		NO			
Wire gauge		>22AWG(0.3247mm ²)			
Resolution		12-bit			
Excitation frequency		10kHz			
VRMS		7V			
VP-P		3.15±27%			
PI500 PG4 terminal description					
No.	Label no.	Description	No.	Label no.	Description
1	EXC1	Rotary transformer excitation negative	4	SINLO	Rotary transformer feedback SINLO negative
2	EXC	Rotary transformer excitation positive	5	COS	Rotary transformer feedback COS positive
3	SIN	Rotary transformer feedback SIN positive	6	COSLO	Rotary transformer feedback COSLO negative
OC PG card(PI500 PG5)					
PI500 PG5 specifications					
User interface		Terminal block			
Spacing		3.5mm			
Screw		Slotted			
Swappable		NO			
Wire gauge		16-26AWG(1.318~0.1281mm ²)			
Maximum frequency		100KHz			
PI500 PG5 terminal description					
No.	Label no.	Description	No.	Label no.	Description
1	A	Encoder output A signal	6	A0	PG card 1:1 feedback output A signal
2	B	Encoder output B signal	7	B0	PG card 1:1 feedback output B signal
3	Z	Encoder output Z signal	8	Z0	PG card 1:1 feedback output Z signal
4	15V	Output 15V/100mA power	9	PE	Shielding terminal
5	GND	Power ground			

Appendix IV CAN bus communication card use description

IV-1.Overview

CAN bus communication card is suitable for all series of PI500 frequency inverters.Protocol details,please refer to 《CAN bus communication protocol》 document.

IV-2.Mechanical installation and terminal functions

IV-2-1 Mechanical installation modes:

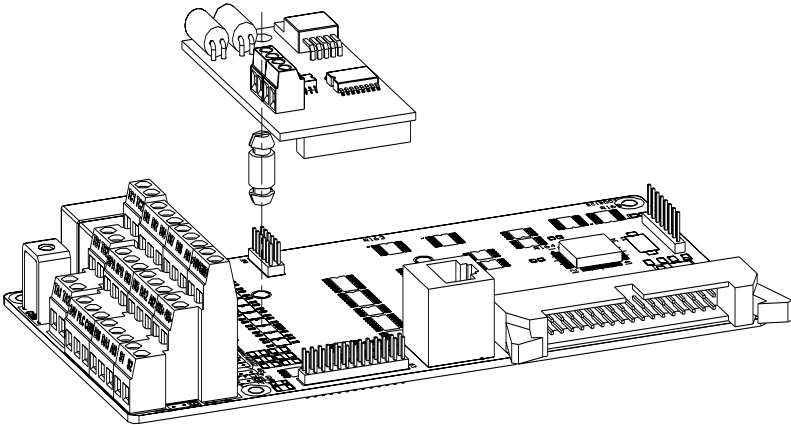

Diagram IV-1: CAN bus communication card's installation on SCB

IV-2-2 Terminal function

Class	Terminal Symbol	Terminal Name	Description
Communication	CANH	communication interface terminal	CANcommunication input terminal
	CANL		
	COM	CAN communication power ground	CAN 5V power output terminal
	P5V	CAN communication power output ground	

Appendix V: Instruction of Profitbus –DP communication card

V-1.Outline

9KDP1 meet the international standard PROFIBUS fieldbus, powtran technology 9K series inverter use it together to achieve the drive to become a part of fieldbus complete control of real fieldbus. Before using this product, please carefully read this manual

V-2 Terminal function

v-2-1 DIP switch description

Switch position No.	Function	Instruction		
1,2	DP Card and the drive baud rate selection	Bit 1	Bit 2	Baud Rate
		OFF	OFF	115.2K
		OFF	ON	208.3K
		ON	OFF	256K
ON	ON	512K		
3-8	Profibus-DP Communication from the station address	6 Binary Consisting of 64-bit binary address, more than 64 outside the address can be set only by function code. The following lists some slave address and switch settings Address switch settings 0 00 0000 7 00 0111 20 01 0100		

Table V-1: Switch Functions

V-2-2 Terminal Function

1) External communication terminal J4-6PIN

Terminal NO	Mark	Function	Terminal NO	Logo	Function
1	GND	5V power ground	4	TR+	Cable Positive
2	RTS	Request to send signal	5	+5V	5Vpower
3	TR-	Cable negative	6	E	The grounding end

Table V-2: External communication terminal function

2) Upper machine communication interface SW1-8PIN

Terminal No	Terminal logo	Function	Terminal No	Terminal logo	Function
1	BOOT0	ARM boot selection	5	PC232T	PC 232 communication Sending side
2	GND	Power ground	6	PC232R	PC 232 communication receiving side
3	VCC	Power	7	RREST	ARM reset
4	Reserved	Reserve	8	GND	Power ground

Table V-3: PC communication terminal function

V-2-3 LED Light function

LEDlight	Function definition	Description
Green	Power light	If DP card and drive interfaces connected, the inverter after power LED should be in the steady state
Red	DP CARDS and	DP Card and inverter connected to the normal state of the

Appendix V

	frequency converter serial port connect light	LED is lit, flashing indicates the connection is intermittent (for interference), and drive off when a serial connection is unsuccessful (You can check the baud rate setting)
Yellow	DP card and Profibusmain connection indicator light	DP Profibus master card and connect normal state of the indicator is lit. flashing indicates the connection is intermittent (for interference), and Profibus master is off when connection is unsuccessful (you can check the slave address, data formats, and Profibus cable)

Table V-4: LED light function description

Product Information Feedback

Dear user:

Thank you for your interest in and purchasing Powtran products! In order to better serve you, we want to be able to timely get your personal information and the related information of the purchased Powtran products so as to understand your current and future further demand to Powtran products, we would appreciate your valuable feedback. For your convenience, please visit our website <http://www.powtran.com> and then click "Technologies and Services" and "Download" columns to submit your feedback information.

- 1) Download the update product manuals you need
- 2) View the technical information on products, such as operation instructions, specifications and features, FAQ, etc.
- 3) Share application cases.
- 4) Technical advisory and online feedback
- 5) Feedback the product and demand information for via e-mail
- 6) Inquire the latest products and access to various types of warranty and extend additional services
- 7) When product improvements, this manual content will change without prior notice.